



N

1:160

TT

1:120

 **ARNOLD**®

2025

INDEX

Inhaltsverzeichnis • Index • Indice • Índice

Club	4
Shows & Fairs	5
Arnold N	8
Arnold TT	118
Spare parts	206
Accessories	130
HM7000	132
Hornby TT:120	134
Main index	142
Still available index	144

Un CLUB para cada aficionado



RENFE, set de 2 cisternas de 2 ejes Tren Herbicida "SINTRA", ép. IV
Modelo exclusivo 2025 reservado para socios

Ventajas por ser socio del Club

Promociones en la web de Hornby
(incluso Arnold, Electrotren, Rivarossi, Jouef, Lima)

Vagones exclusivos en escala N

Revista del Club Electrotren















Catálogo de Arnold (o Electrotren como alternativa)

www.clubelectrotren.com

Meet us SHOWS AND FAIRS

2025

* Dates not yet confirmed

FEB	MAR	APR	MAY	JUN	JUL	SEP	OCT	NOV	
 <p>28jan-01feb</p> <p>Nuremberg Toy Fair Nuremberg</p>		 <p>10apr-13apr</p> <p>Intermodellbau Dortmund</p>					 <p>03oct-05oct</p> <p>Modell Hobby Spiel Leipzig</p>	 <p>31oct-02nov</p> <p>Faszination Modellbau Friedrichshafen</p>	 <p>20nov-23nov</p> <p>N-Scale Convention Stuttgart</p>
		 <p>25apr-27apr</p> <p>Modellbaumesse Tulln</p>							
	 <p>08mar-09mar</p> <p>Lleida Expo Tren Lleida</p>		 <p>26may-27may*</p> <p>Martotren Barcelona</p>					 <p>07nov-09nov*</p> <p>ExpoModelTren Madrid</p>	
	 <p>08mar-09mar</p> <p>Model Expo Italy Verona</p>					 <p>26sep-28sep</p> <p>Hobby Model Expo Novagro</p>			
	 <p>15mar-16mar</p> <p>Salon International du Train Miniature Bourges</p>							 <p>01nov-02nov</p> <p>Savoie Modélisme Chambéry</p>	 <p>28nov-30nov</p> <p>Rail Expo Dreux</p>

SYMBOLS

Zeichenerklärung • Symboles • Simboli • Símbolos

 Motorized model, with digital DCC decoder
Gleichstrommodell, digital mit DCC-Decoder
Modèle motorisé pour courant continu avec décodeur DCC
Modello motorizzato in corrente continua, con decodere digitale
Modelo motorizado, con decodere digital DCC

 Motorized model, with digital decoder and sound
Gleichstrommodell, digital mit Sound
Modèle motorisé pour courant continu avec décodeur DCC sonorisé
Modello motorizzato in corrente continua, con sound decoder
Modelo motorizado, con decodere digital y sonido

 HM7000 Bluetooth decoder onboard
Integrierter HM7000-Bluetooth-Decoder
Décodeur Bluetooth HM7000 intégré
Decoder Bluetooth HM7000 integrato
Decoder Bluetooth HM7000 integrado

 Digital plug NEM 662 (Next-18)
Digitalschnittstelle NEM 662 (Next-18)
Prise NEM pour décodeur 662 (Next-18)
Presa NEM per decodere 662 (Next-18)
Enchufe para conector digital NEM 662 (Next-18)

 Plug for digital decoder, 6-pins
Lok mit 6-Decoder-Schnittstelle
Prise pour décodeur DCC 6 broches
Presa NEM per decodere 6 poli
Enchufe para conector digital 6 pins

 Digital plug E24
Digitalschnittstelle E24
Prise pour décodeur E24
Presa per decodere E24
Enchufe para conector digital E24

 Overall length in mm
Länge über Puffer in (mm)
Longueur hors tampons (mm)
Lunghezza fuori respingenti (mm)
Longitud entre topes (mm)

 Built-in interior details
Inneneinrichtung eingebaut
Aménagement intérieur
Modello con dettagli interni
Modelo con interiores detallados

 Built-in interior illumination
Mit eingebauter Innenbeleuchtung
Modèle avec éclairage intérieur
Modello con illuminazione interna
Modelo con iluminación interior

 Model with interior lighting and touch control
Modell mit Innenbeleuchtung und Berührungssensor
Modèle avec éclairage intérieur avec commande tactile
Modello con illuminazione interna con controllo tattile
Modelo con iluminación interior y control táctil

 Extending coupling mechanism
Kurzkupplungs-Mechanik eingebaut
Attelages à élongation
Gancio corto con cinematismo a norma NEM
Con mecanismo elástico para enganche corto

 Power supply can be switched to catenary
Umschaltbar auf Oberleitungsbetrieb
Prise de courant par caténaire fonctionnelle
Alimentazione da linea aerea
Pantógrafa con toma de corriente funcional

 Metal die-cast chassis with plastic body shell
Fahrwerk aus Metallspritzguss, Lokomotivgehäuse aus Kunststoff
Châssis métallique avec carrosserie en plastique
Telaio in metallo, corpo in plastica
Chasis metálico con carrocería en plástico

 Metal die-cast chassis with metal die-cast body shell
Fahrwerk und Lokomotivgehäuse aus Metallspritzguss
Châssis et carrosserie en métal
Telaio in metallo, corpo in metallo
Chasis y carrocería en metal

 Motor with flywheel
Motor mit Schwungmasse
Moteur avec volant d'inertie
Motore con volano
Motor con volante de inercia

 Detailed cabin interior
Detaillierter Kabineninnenraum
Intérieur détaillé de la cabine
Interni della cabina dettagliati
Interior detallado de la cabina

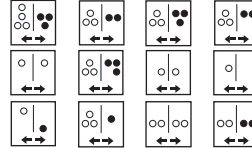
 Locomotive with white/red reversing headlights
Spitzen- und Schlussbeleuchtung mit der Fahrtrichtung wechselnd
Eclairage avec inversion blanc/rouge
Locomotiva con luci reversibili bianche e rosse
Locomotora con luces reversibles blancas y rojas

NEW New item from new tooling
Neues Modell aus neuen Formen
Nouveau modèle de nouveaux outillages
Nuovo modello da nuovi stampi
Nuevo modelo de nuevos moldes

NEW New item with tooling modification
Neues Modell mit Werkzeugänderungen
Nouveau modèle avec modifications d'outillage
Nuovo modello con modifiche di stampo
Nuevo modelo con modificaciones de moldes

NEW New item 2025
Neues Modell 2025
Nouveau modèle 2025
Nuovo modello 2025
Nuevo modelo 2025

PERIOD

Epoche • Époque • Epoca • Época

 Period / Epoche / Époque / Época / Epoca I: 1848 - 1920

 Period / Epoche / Époque / Época / Epoca II: 1921 - 1940

 Period / Epoche / Époque / Época / Epoca III: 1941 - 1970

 Period / Epoche / Époque / Época / Epoca IV: 1971 - 1990

 Period / Epoche / Époque / Época / Epoca V: 1991 - 2006

 Period / Epoche / Époque / Época / Epoca VI: 2007 -

SCALE

Maßstab • Échelle • Scala • Escala

 1:160

 1:120

Tutti i diritti sui loghi FS, Frecciarossa, Frecciabianca e Frecciargento sono di proprietà di Ferrovie dello Stato Italiane S.p.A. e Trenitalia S.p.A.

Arnold Catalogue 2025

English

Dear Model Railway Enthusiasts,
Are you ready to discover a world
in scale?

We are excited to present our new
2025 Catalog!
What awaits you?

- Exclusive models: impeccable details, historical accuracy, and technical innovation.
- Unmissable novelties: limited editions you won't want to miss.
- Products from around the globe: an international selection to inspire every enthusiast, wherever you are.
- Unique accessories: complete your layouts with extraordinary elements.

We know that every detail matters. That's why our catalog has been designed to delight both experienced collectors and newcomers alike, with a special focus on quality and variety.

Because model railroading isn't just a hobby—it's a lifelong passion!

Deutsch

*Lieber Modelleisenbahner,
Für uns ist die Modelleisenbahn
eine Leidenschaft, genau wie für
Sie.*

*Und daher möchten wir auch 2025
Ihren hohen Erwartungen an uns
nicht enttäuschen.*

*Nicht nur die Liebe zum Detail
ist was Arnold auszeichnet, auch
die Internationalität: Egal ob
Deutschland, Frankreich, Italien,
Spanien, Osteuropa oder die USA
– wir lieben Eisenbahnen aus der
ganzen Welt.*

*Wir hoffen, dass wir Ihnen auch
in diesem Jahr wieder eine breite
Palette von interessanten Neuheiten
vorstellen können.*

*Neue Lokomotiven, Reisezugwagen
und Güterwagen sind nur ein Teil
dessen, was auf Sie 2025 wartet.*

Lassen Sie sich überraschen!

Français

*Chers passionnés de modélisme
ferroviaire,
Prêts à découvrir un monde à
l'échelle ?*

*Nous sommes ravis de vous
présenter notre nouveau Catalogue
2025 !*

Qu'est-ce qui vous attend ?

- Modèles exclusifs : des détails impeccables, une fidélité historique et une innovation technique.
- Nouveautés incontournables : des éditions limitées à ne pas manquer.
- Produits du monde entier : une sélection internationale pour inspirer chaque passionné, où que vous soyez.
- Accessoires uniques : complétez vos décors avec des éléments extraordinaires.

Nous savons que chaque détail compte. C'est pourquoi notre catalogue a été conçu pour séduire aussi bien les collectionneurs expérimentés que les nouveaux passionnés, avec un soin particulier porté à la qualité et à la diversité des propositions.

Parce que le modélisme ferroviaire n'est pas qu'un hobby, c'est une passion pour la vie !

Italiano

*Caro fermodellisti,
Pronti a scoprire un mondo in
scala?*

*Siamo entusiasti di presentare il
nostro nuovo Catalogo 2025!
Cosa vi attende?*

- Modelli esclusivi: dettagli impeccabili, fedeltà storica e innovazione tecnica.
- Novità imperdibili: edizioni limitate che non puoi lasciarti scappare.
- Prodotti da tutto il mondo: una selezione internazionale per ispirare ogni appassionato, ovunque si trovi.
- Accessori unici: completa i tuoi scenari con elementi straordinari.

Sappiamo che ogni dettaglio conta. Per questo, il nostro catalogo è stato pensato per entusiasmare sia i collezionisti più esperti che i nuovi appassionati, con un occhio di riguardo alla qualità e alla varietà delle proposte.

Perché il fermodellismo non è solo un hobby, è una passione che dura tutta la vita!

Español

*Queridos aficionados al modelismo
ferroviario,
¿Están listos para descubrir un
mundo a escala?*

*Estamos emocionados de presentar
nuestro nuevo Catálogo 2025.
¿Qué les espera?*

- Modelos exclusivos: detalles impecables, fidelidad histórica e innovación técnica.
- Novedades imprescindibles: ediciones limitadas que no querrán perderse.
- Productos de todo el mundo: una selección internacional para inspirar a cada aficionado, donde sea que estén.
- Accesorios únicos: completa tus escenarios con elementos extraordinarios.

Sabemos que cada detalle importa. Por eso, nuestro catálogo ha sido diseñado para entusiasmar tanto a los coleccionistas más experimentados como a los recién llegados, con un enfoque especial en la calidad y la variedad.

Porque el modelismo ferroviario no es solo un pasatiempo, ¡es una pasión para toda la vida!



© Vincent Burgun

 **ARNOLD**

Inhalt • Index

Dampflokomotiven	10
<i>Steam locomotives</i>	10
Diesellokomotiven	18
<i>Diesel locomotives</i>	18
Elektrolokomotiven	30
<i>Electric locomotives</i>	30
Reisezugwagen	24
<i>Coaches</i>	24
Güterwagen	80
<i>Wagons</i>	80
Bereits lieferbar	90
<i>Still available</i>	90



www.arnoldmodel.com



Lieber Modelleisenbahner,

Für uns ist die Modelleisenbahn eine Leidenschaft, genau wie für Sie.

Und daher möchten wir auch 2025 Ihren hohen Erwartungen an uns nicht enttäuschen.

Nicht nur die Liebe zum Detail ist was Arnold auszeichnet, auch die Internationalität: Egal ob Deutschland, Frankreich, Italien, Spanien, Osteuropa oder die USA – wir lieben Eisenbahnen aus der ganzen Welt.

Wir hoffen, dass wir Ihnen auch in diesem Jahr wieder eine breite Palette von interessanten Neuheiten vorstellen können.

Neue Lokomotiven, Reisezugwagen und Güterwagen sind nur ein Teil dessen, was auf Sie 2025 wartet.

Lassen Sie sich überraschen!

Die Baureihe 95

HANOMAG
Hannoversche
Maschinenbau-
Actien-Gesellschaft
vorm. Georg Egestorff
HANNOVER-LINDEN

1 E1-Zwilling-Heißdampf-Güterzug-Tenderlokomotive Gt 57.18 der Deutschen Reichsbahn

DK 621.132
Hanomag-Lehrblatt
131

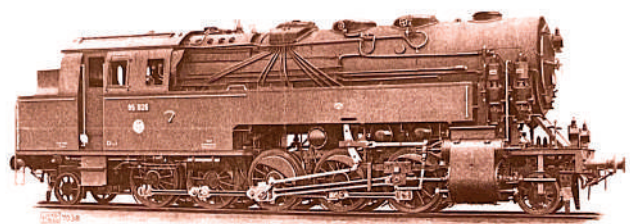

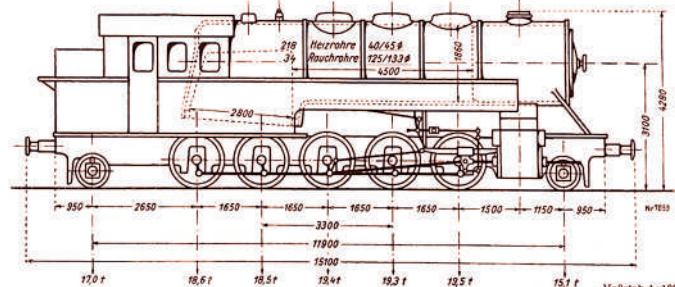

1 E1-Zwilling-Heißdampf-Güterzug-Tenderlokomotive der Deutschen Reichsbahn.
Betr.-Nr. 95 001 u. folg. - Gattung Gt. 57.18.

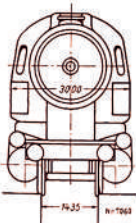

Hauptabmessungen:

Spurweite	1435 mm
Triebwerk	700/650/1400 mm
Laufrad-Durchmesser	830 mm
Dampfdruck	14 at
Heizfläche der Feuerkammer, fl.	17,0 m ²
Heizfläche des Rohrs, fl.	182,5 m ²
Überhitzerheizfläche	62,5 m ²
Heizfläche, gesamt	262,5 m ²
Leergewicht	103 700 kg
Dienstgewicht	127 400 kg
Reibungsgewicht	95 300 kg
Wasservorrat	12 m ³
Kohlenvorrat	4 t
Fester Räderstand	3 300 mm
Gesamtrasterstand	11 000 mm
Größte Länge einschließlich Puffer	15 100 mm
Zugkraft (0,6)	19 100 kg

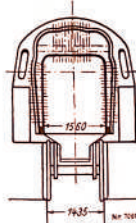

Die Baureihe 95 bei der Deutschen Reichsbahn

In den Jahren 1922/23 lieferte Borsig 18 Dampflokomotiven der Bauart 1' E 1' h2, welche noch als preußische Gattung T20 bestellt war. Weitere 27 Maschinen wurden von Hanomag im Zeitraum 1923/24 gebaut. Im ursprünglichen Umzeichnungsplan der Deutschen Reichsbahn Gesellschaft war die Baureihennummer 77 für die pr. T20 vorgesehen, im endgültigen Umzeichnungsplan von 1925 erhielten sie dann die Baureihennummer 95.

Der Plan mit diesen Lokomotiven den Zahnradbetrieb auf Steilstrecken zu beenden scheiterte am hohen Gewicht der neuen Lokomotiven jedoch verfügte die Deutsche Reichsbahn hiermit über hervorragende Maschinen für den Güterzug- und Schiebebetrieb auf Gebirgstrecken, der ihr den Beinamen „Bergkönigin“ einbrachte. Ihr Einsatz erfolgte vorrangig in Bahnbetriebswerken welche mit Güterzug und Schiebeleistungen im Bergland betraut waren, so unter anderem in den Bahnbetriebswerken Geislingen, Pressig-Rothenkirchen, Neuenmarkt-Wirsberg, Suhl, Arnstadt oder Probstzella.

Nach dem Zweiten Weltkrieg verblieben auf dem Gebiet der westlichen Besatzungszonen, der späteren Bundesrepublik Deutschland und 12 Maschinen.

Diese wurden von der Deutschen Bundesbahn bis 1957 eingesetzt. Außerdienst gestellt wurden die Lokomotiven bis 1959 verschrottet. Die restlichen Maschinen verblieben nach dem Krieg auf dem Gebiet der späteren DDR. Die dortige DR konnte auf diese Lokomotiven nicht verzichten und ließ in den sechziger 24 davon in Meiningen auf Ölhauptfeuerung umbauen. Bei zehn Maschinen wurde zudem ein neuer Kessel eingebaut. 1981 endete der Planeinsatz der letzten im Bahnbetriebswerk Probstzella und der dazugehörigen Lokeinsatzstelle Sonneberg stationierten Maschinen. Die 95 016 wurde zu Heizzwecken auf Kohlefeuerung zurückgebaut. Ebenso erfolgte ein Rückbau auf Kohlefeuerung bei der 95 027, welche als Traditionslok vorgesehen war. Diese Lok ist auch heute noch betriebsfähig vor Sonderzügen im Einsatz.

Einige Lokomotiven blieben dank verschiedener Museen, Vereine und privater Enthusiasten erhalten.

95 009 - Pressnitztalbahn GmbH, hinterstellt in Sonneberg
95 016 - Deutsches Dampflokotivmuseum Neuenmarkt-Wirsberg

95 020 - Technikmuseum Speyer

95 028 - Eisenbahnmuseum Bochum



HN2597/HN2597S



NEW



DR, Dampflokomotive 95 021, kohlegefeuert, mit modernisiertem Sandkasten

DR, locomotora de vapor 95 021, alimentada por carbón, con caja de arena modernizada

DR, locomotiva a vapore 95 021, alimentazione a carbone, con sabbiera modernizzata

DR, locomotive à vapeur 95 021, alimentée au charbon, avec sablière modernisée

DR, steam locomotive 95 021, coal-fired, with modernized sand box

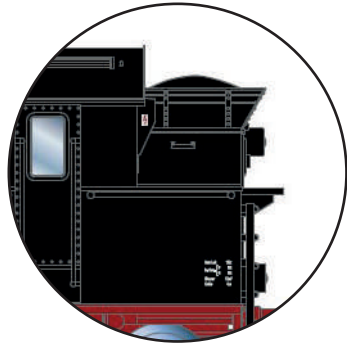

HN2597/S mit Kohlekasten

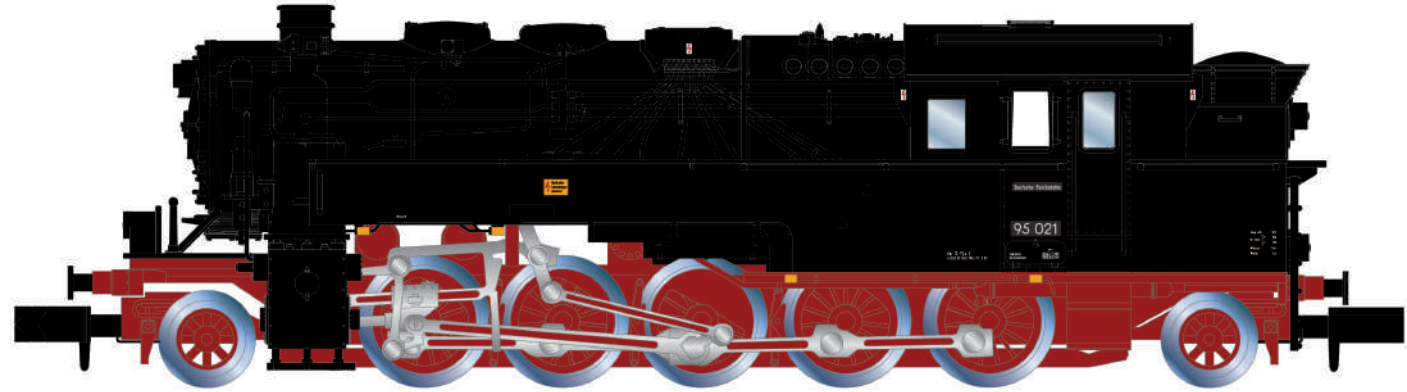

Highlights unserer neuen Arnold-Modelle:

- HN2597S und HN2598S ab Werk mit fest eingebautem Sound-Decoder
- HN2597S und HN2598S ab Werk mit digital schaltbarer Triebwerksbleuchtung
- HN2597 und HN2598 ab Werk mit 6-poliger Digitalschnittstelle nach NEM 651
- HN2597/S mit Kohlekasten, HN2598/S mit Öltender
- Beide Modelle mit modernisierten Sandkästen



Die Baureihe 95



Jetzt mit
Triebwerksbeleuchtung



HN2598/HN2598S



NEW



DR, Dampflokomotive 95 0024, ölgefeuert, mit modernisiertem Sandkasten

DR, locomotora de vapor 95 0024, alimentada por aceite, con caja de arena modernizada

DR, locomotiva a vapore 95 0024, alimentazione ad olio, con sabbiera modernizzata

DR, locomotive à vapeur 95 0024, alimentée au fioul, avec sablière modernisée

DR, steam locomotive 95 0024, oil-fired, with modernized sand box

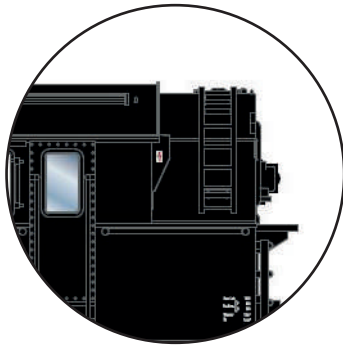

HN2598/S mit Öltender

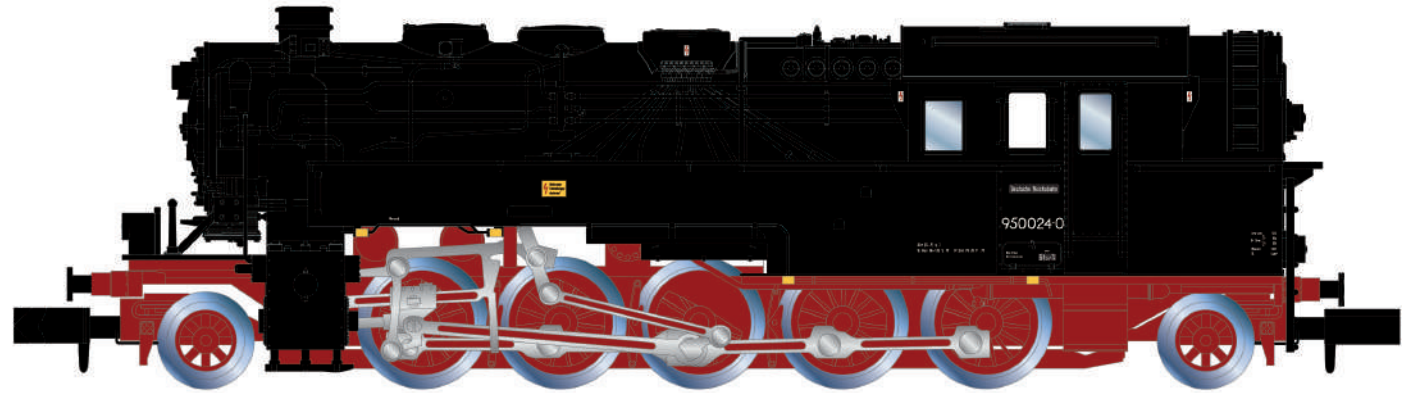

© Brutzer



HN2597/S + HN2598/S
mit Triebwerksbeleuchtung

HN2663/HN2663S

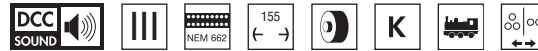

NEW



DR, Dampflokomotive Baureihe 18 201, Kohletender, 1. Originalfarbgebung (grün ohne Zierlinie)

DR, locomotora de vapor 18 201, con tender de carbón, 1ª decoración original (verde sin banda decorativa)

DR, locomotiva a vapore 18 201, con tender a carbone, 1ª livrea originale (verde senza fascia decorativa)

DR, locomotive à vapeur 18 201, avec tender à charbon, 1^{ère} livrée d'origine (vert sans bande décorative)

DR, steam locomotive class 18 201, coal tender, 1st original livery (green without decorative line)

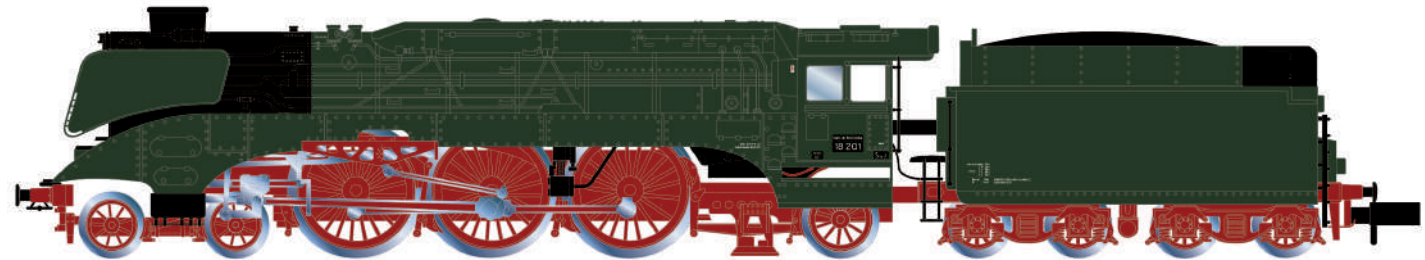

18 201 mit Zusatztender

Die 18 201 der Versuchs- und Entwicklungsstelle Maschinenwirtschaft Halle wurde 1961 auf Basis der 61 002, einer ehemaligen Henschel-Stromlinienlokomotive, zur Durchführung von Versuchs- und Erprobungsfahrten umgebaut. Das Ziel war, eine leistungsfähige Schnellzuglokomotive für den Einsatz auf Strecken mit hohen Geschwindigkeiten zu schaffen.

Seit 1987 wurde die Lokomotive häufig mit einem zusätzlichen Tender eingesetzt, um ihre Reichweite zu erhöhen. Dies war und ist besonders für Langstreckenfahrten wichtig. Der Zusatztender ist ein umgebauter Einheitstender, der auch bei heutigen Sonderfahrten der Lok oft zum Einsatz kommt.

HN2664/HN2664S

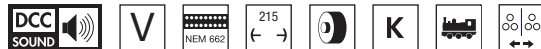

Dampflokomotive 18 201, Ölender, rote Farbgebung mit grünem Tender

Locomotora de vapor 18 201, con tender de fuel, decoración roja con tender verde

Locomotiva a vapore 18 201, con tender ad olio combustibile, livrea rossa con tender verde

Locomotive à vapeur 18 201, avec tender à fioul, livrée rouge avec tender vert

Steam locomotive 18 201, fuel tender, in red livery with green tender

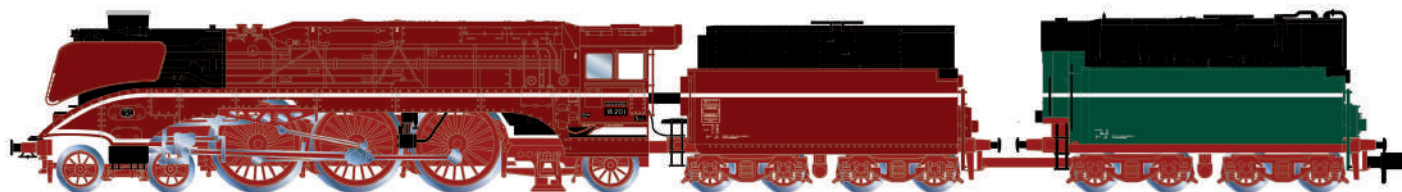

NEW

HN2665/HN2665S

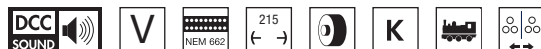

DR, Dampflokomotive 02 0201-0, chromgrüne Farbgebung mit weißer Zierlinie, mit Ölfeuerung und Zusatztender

DR, locomotora de vapor 02 0201-0, decoración verde cromo con línea decorativa blanca, con tender de alta capacidad y tender adicional

DR, locomotiva a vapore 02 0201-0, livrea verde cromo con linea decorativa bianca, con tender ad olio ad alta capacità e tender aggiuntivo

DR, locomotive à vapeur 02 0201-0, livrée vert chrome avec ligne de décoration blanche, avec tender à huile à grande capacité et tender supplémentaire

DR, steam locomotive 02 0201-0, chrome green livery with white decoration line, with high capacity fuel tender and additional tender

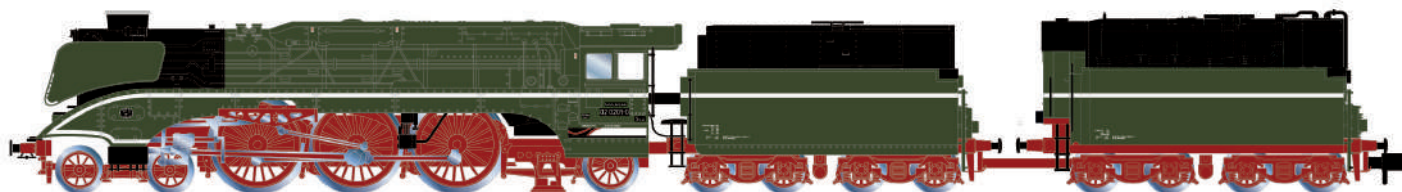

NEW

Highlights unserer neuen Arnold-Modelle:

- HN2663S/64S/65S mit auf der Hauptplatine integriertem Sounddecoder und Triebwerksbeleuchtung
- HN2664/S und HN2665/S mit fest gekuppeltem Zusatztender

HN2546/HN2546S

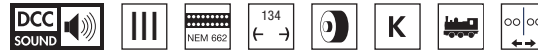

NEW



SNCF, Damplokomotive 141R 568 mit Speichen- und Boxpokrädern und einem Kohlentender mit genietetem Wasserkasten, in schwarz/roter Lackierung

SNCF, locomotora de vapor 141R 568 con ruedas de radios y Boxpok y tender de carbón con depósito de agua con remaches, decoración negra/roja

SNCF, locomotiva a vapore 141R 568 con ruote a razze e ruote Boxpok e tender per carbone con casse d'acqua chiodate, livrea nera/rossa

SNCF, locomotive à vapeur 141R 568 avec roues à rayons et Boxpok et tender à charbon avec boîtes à eau clouées, livrée noire/rouge

SNCF, steam locomotive 141R 568 with spoked and boxpok wheels and coal tender with riveted water tanks, black/red livery



Avec tender à charbon



© Didier Duforest

Le modèle 141R d'Arnold

Après les premiers modèles de notre 141R avec roues Boxpok et grand tender à fuel, voici les nouveaux modèles avec tender à charbon et roues à rayons (essieu moteur avec roues Boxpok). Le châssis de la locomotive a été revu pour une meilleure accessibilité pour l'entretien. En ce qui concerne le son de la locomotive, nous avons bien entendu remplacé le son du brûleur à mazout par celui du pelletier de charbon.



HN2544/HN2544S

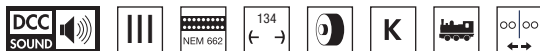

SNCF, Dampflokomotive 141R 463 mit Speichenrädern und einem Kohlentender mit genietetem Wasserkasten, in schwarzer Lackierung

SNCF, locomotora de vapor 141R 463 con ruedas de radios y tender de carbón con depósito de agua con remaches, decoración negra

SNCF, locomotiva a vapore 141R 463 con ruote a razze e tender per carbone con casse d'acqua chiodate, livrea nera

SNCF, locomotive à vapeur 141R 463 avec roues à rayons et tender à charbon avec boîtes à eau clouées, livrée noire

SNCF, steam locomotive 141R 463 with spoked wheels and coal tender with riveted water tanks, black livery

NEW



Roue Boxpok comme roue motrice



HN2545/HN2545S

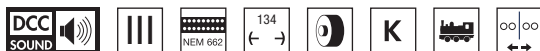

SNCF, Dampflokomotive 141R 460 mit Speichen- und Boxpokrädern und einem Kohlentender mit genietetem Wasserkasten, in grüner Lackierung

SNCF, locomotora de vapor 141R 460 con ruedas de radios y Boxpok y tender de carbón con depósito de agua con remaches, decoración verde

SNCF, locomotiva a vapore 141R 460 con ruote a razze e ruote Boxpok e tender per carbone con casse d'acqua chiodate, livrea verde

SNCF, locomotive à vapeur 141R 460 avec roues à rayons et Boxpok et tender à charbon avec boîtes à eau clouées, livrée verte

SNCF, steam locomotive 141R 460 with spoked and boxpok wheels and coal tender with riveted water tanks, green livery

NEW





Jules Verne



Le Jules Verne circule le matin de Nantes à Paris avec le numéro TEE 30 et en fin d'après-midi de Paris à Nantes avec le numéro TEE 31, avec un unique arrêt intermédiaire à Angers. À sa création, le 28 septembre 1980, il est tracté par une CC 72000, même sur la section électrifiée entre Le Mans et Paris. Ses horaires de circulation sont proches de ceux du Maine Océan et la durée du trajet est de 3 h 17 dans chaque sens.

Avec l'électrification de la section Le Mans-Nantes, le trajet est réduit à 3 h 3 en septembre 1983, puis à 2 h 48 au service d'hiver 1984-1985. Tracté par une BB 22200, il circule à 200 km/h sur plusieurs sections entre Nantes et Le Mans.

Il circule pour la dernière fois le 22 septembre 1989, avec la mise en service des TGV entre Paris et Nantes qui empruntent la branche ouest de la LGV Atlantique.

© Fabrice Lanoue



HN2653/HN2653S

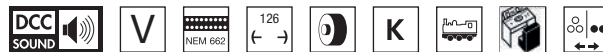

SNCF, Diesellokomotive CC 72006 in „Multiservice“-Farbgebung mit rotem SNCF-Logo auf einer Frontseite

SNCF, locomotora diésel CC 72006, decoración "Multiservice" con logotipo rojo SNCF en un testero

SNCF, locomotiva diesel CC 72006, livrea "Multiservice" con logo SNCF rosso su una testata

SNCF, locomotive diesel CC 72006, livrée « Multiservice » avec logo rouge SNCF sur une face frontale

SNCF, diesel locomotive CC 72006, "Multiservice" livery with red SNCF logo on one front side

NEW

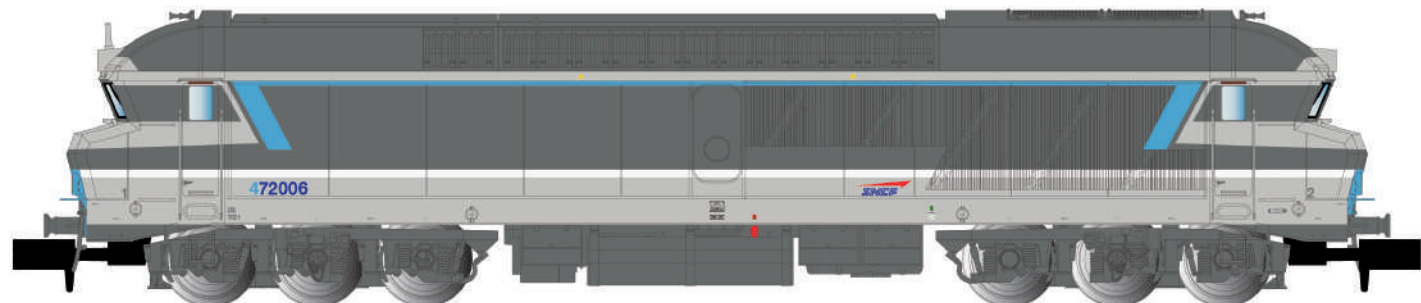

HN2651/HN2651S

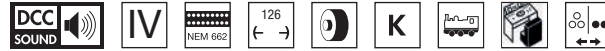

NEW



SNCF, Diesellokomotive CC 72071 „Marseille“, Ursprungslackierung mit Nummernschildern

SNCF, locomotora diésel CC 72071 “Marseille”, decoración original

SNCF, locomotiva diesel CC 72071 “Marseille”, livrea d'origine

SNCF, locomotive diesel CC 72071 « Marseille », livrée original

SNCF, diesel locomotive CC 72071 “Marseille”, original livery

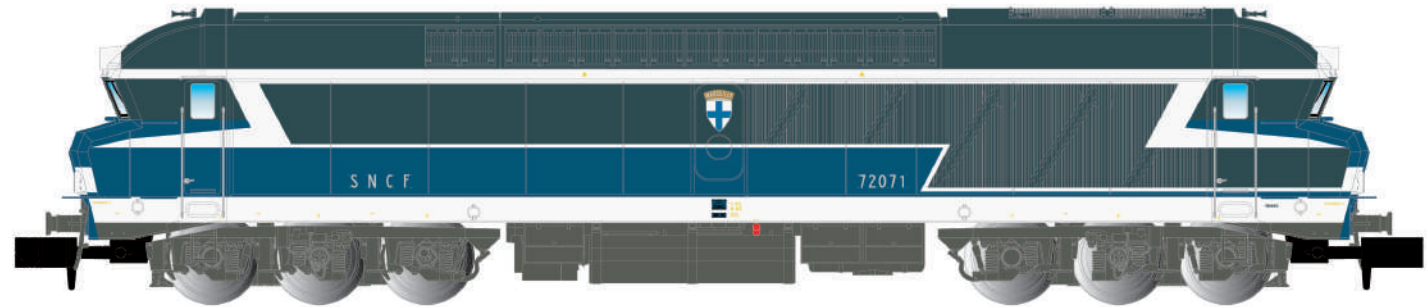

TEE « Jules Verne » de 1980/81



HN2651

HN4498

HN4498

HN4498



HN4499

HN4499

HN4499

HN4499

HN2654/HN2654S



NEW



FS, Diesellokomotive der Reihe D.445, 1. Bauserie, grün-braune Farbgebung mit runden Fenstern

FS, locomotora diésel D.445, 1ª serie, con cristales redondeados, decoración original verde/marrón "Isabella"

FS, locomotiva diesel D.445, 1ª serie, con vetri curvi, livrea originale verde e "Isabella"

FS, locomotive diesel D.445, 1^{ère} série, avec pare-brises arrondies, livrée originale verte et « Isabella »

FS, diesel locomotive D.445, 1st series, with rounded glasses, original green "Isabella" livery



Caratteristiche tecniche

- Meccanica con telaio in metallo, motore coreless centrale con trasmissione a doppio albero cardanico su entrambi gli assi di entrambi i carrelli, due ruote con anello di aderenza
- Impianto elettrico con interfaccia Next18 (NEM 662) per decoder DCC e DCC Sound, predisposizione per altoparlante "sugar cube" 11 x 15 mm
- Luci bianche di testa e rosse di coda con commutazione automatica in base al senso di marcia, con comando indipendente di luci rosse e terzo faro (in funzionamento digitale) e possibilità di esclusione selettiva delle luci delle testate, in funzionamento digitale tramite decoder e in funzionamento analogico tramite DIP switches
- Fanaleria, vetri frontali, loghi FS ed accoppiatori coerentemente differenziati in base alla serie e all'epoca riprodotta.



Photo: Andrea Strini

HN2655/HN2655S

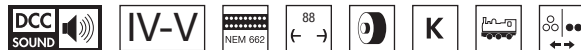

NEW

FS, Diesellokomotive der Reihe D.445, 2. Bauserie mit zwei Stirnlampen, „MDVC“-Farbgebung

FS, locomotora diésel D.445, 2ª serie, con dos faros bajos, decoración "MDVC"

FS, locomotiva diesel D.445, 2ª serie, con due fanali bassi, livrea "MDVC"

FS, locomotive diesel D.445, 2^{ème} série, avec deux phares inférieurs, livrée « MDVC »

FS, diesel locomotive D.445, 2nd series, with two low lamps, "MDVC" livery



Fotomontage / Fotomontaje / Fotomontaggio / Photomontage

HN2656/HN2656S

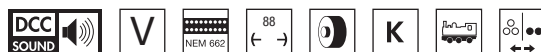

NEW

FS, Diesellokomotive der Reihe D.445, 3. Bauserie mit vier Stirnlampen, „XMPR“ Farbgebung (1. Version)

FS, locomotora diésel D.445, 3ª serie, con cuatro faros bajos, decoración "XMPR" (1ª versión)

FS, locomotiva diesel D.445, 3ª serie, con quattro fanali bassi, livrea "XMPR" (1ª versione)

FS, locomotive diesel D.445, 3^{ème} série, avec quatre phares inférieurs, livrée « XMPR » (1^{ère} version)

FS, diesel locomotive D.445, 3rd series, with four low lamps, "XMPR" (1st version) livery



Fotomontage / Fotomontaje / Fotomontaggio / Photomontage

Les RGP II



Les RGP II

Conçues par la DEA (Division de Etudes Autorails) de la SNCF, les RGP 2 (Rames à Grand Parcours bimoteur) sont équipées de 2 moteurs Renault type 517 développant 300 CV à 1500 tr/mn, le même type de moteur que l'on retrouve également sur les autorails X 3800 et X 2400. Construites en 20 exemplaires de 1954 à 1955, les RGP2 sont composées d'une motrice X 2700 et d'une remorque XR 7700 équipée d'une cabine de conduite, le tout constituant un ensemble indéformable en service normal.

Les RGP2 sont couplables entre eux et avec les RGP1. Elles reçoivent une livrée vert olive et crème, très différente de la livrée rouge et crème des autres autorails

en cours de livraison, ce qui leur faudra le surnom de « lézards verts ».

Rapides et confortables, les RGP2 sont utilisées sur les relations directes entre grandes villes sur de longs trajets, et sur quelques relations internationales touchant Genève, Cerbère ou ou Francfort. Moins véloce que les RGP1 monomoteurs qui ont bénéficié des progrès dans les domaines de la motorisation (moteur diesel MGOde 825 CV) et des transmissions, les RGP2 perdent lentement leur affectation sur de nombreux trains à long parcours au profit des seules RGP1. Les RGP2 sont progressivement regroupées sur Bordeaux et affectées à des services régionaux moins prestigieux, avant d'être retirées du service commercial en 1986.

HN2635/HN2635S



NEW

-  **SNCF, Dieseltriebwagen RGP II, Trieb- und Beiwagen in modernisierter Ausführung, grün-beige Farbgebung**
- SNCF, automotor diésel RGP II con remorque, versión reformada, decoración verde/beige
- SNCF, automotrice diesel RGP II, unità motrice + rimorchiata in versione ristrutturata, livrea verde/beige
- SNCF, autorail diesel RGP II, unité motrice + remorque en version modernisée, livrée vert/beige
- SNCF, diesel railcar RGP II, with motor unit + trailer in re-built version, green/beige livery



Abb. zeigt Spur-H0 Modell / L'image montre le modèle à l'échelle H0 / Picture shows H0 scale model

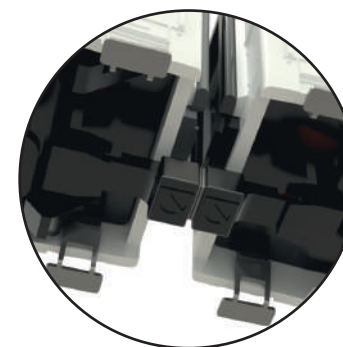

Attelages magnétiques ARNOLD
pour toutes les références de RGP II
(disponibles dans la section « Accessoires »)

HN2636/HN2636S

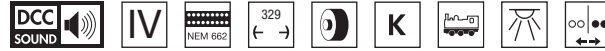

NEW



SNCF, Dieseltriebwagen RGP II, Trieb- und Beiwagen in modernisierter Ausführung, orange-silberne Farbgebung

SNCF, automotor diésel RGP II, versión reformada, decoración naranja/plata

SNCF, automotrice diesel RGP II, unità motrice + rimorchiata in versione ristrutturata, livrea arancio/argento

SNCF, autorail diesel RGP II, unité motrice + remorque en version modernisée, livrée orange/argent

SNCF, diesel railcar RGP II, with motor unit + trailer in re-built version, orange/silver livery



Abb. zeigt Spur-H0 Modell / L'image montre le modèle à l'échelle H0 / Picture shows H0 scale model

Caractéristiques du nouveau modèle Arnold

- Moules entièrement nouveaux
- Moteur 5 pôles plat et bas avec volant d'inertie dans l'unité motorisée cachée sous l'habitacle
- Roues avec le profil extérieur d'origine
- Éclairage intérieur dans l'unité motorisée (X 2700) et dans l'unité de remorque à commande de cabine (XR 7700), contrôlable lorsqu'elle est équipée de décodeurs numériques
- Feux avant et arrière allumés en fonction de la direction en mode analogique (LED blanches dorées et rouges), contrôlables lorsqu'ils sont équipés de décodeurs numériques
- Mécanismes d'attelage fermés à l'arrière de l'unité motorisée et aux deux extrémités de l'unité de remorque

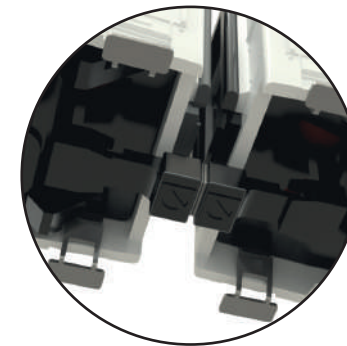

Attelages magnétiques ARNOLD
pour toutes les références de RGP II
(disponibles dans la section « Accessoires »)

HN2637/HN2637S

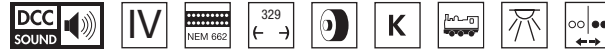

NEW



SNCF, Dieseltriebwagen RGP II, Trieb- und Beiwagen in modernisierter Ausführung, orange-betongraue Farbgebung

SNCF, automotor diésel RGP II, versión reformada, decoración naranja/gris "béton"

SNCF, automotrice diesel RGP II, unità motrice + rimorchiata in versione ristrutturata, livrea arancio/grigio "Betón"

SNCF, autorail diesel RGP II, unité motrice + remorque en version modernisée, livrée orange/gris béton

SNCF, diesel railcar RGP II, with motor unit + trailer in re-built version, orange/concrete grey livery



Abb. zeigt Spur-H0 Modell / L'image montre le modèle à l'échelle H0 / Picture shows H0 scale model

- Pochettes d'attelage NEM 355 sur tous les attelages
- Prises numériques (NEM 662 « Next-18 ») dans l'autorail et la remorque
- Versions numériques avec son (HN2635S/36S/37S) équipées d'un décodeur numérique de son DCC et de haut-parleurs « sugar cube » pour une qualité sonore parfaite
- Tous les détails montés séparément sont préinstallés. L'avant de l'autorail est équipé d'un attelage décoratif et de tuyaux de frein
- L'arrière de la remorque de la cabine de commande peut être équipé d'un soufflet permettant de l'atteler à une deuxième remorque ou à un couple autorail-remorque
- Rayon de courbure minimal : 192 mm

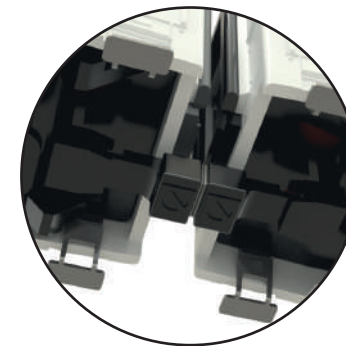

Attelages magnétiques ARNOLD
pour toutes les références de RGP II
(disponibles dans la section « Accessoires »)

HN2638/HN2638D



DR, ASF (Akku-Schleppfahrzeug), grün-rote Farbgebung

DR, vehículo de maniobras ASF, decoración verde/rojo
DR, automotore da manovra ASF, livrea verde/rossa
DR, locomotive de manoeuvre ASF, livrée verte/rouge
DR, ASF shunting device, green/red livery

Caractéristiques du nouveau modèle Arnold

- Neukonstruktion
- Spitzenlicht je nach Fahrtrichtung beleuchtet
- Digitalschnittstelle NEM 651 (6-polig)
- Länge über Puffer 19 mm
- das kleinste angetriebene Modell von ARNOLD



NEW

HN2639/HN2639D



DR, ASF (Akku-Schleppfahrzeug), orange-schwarze Farbgebung

DR, vehículo de maniobras ASF, decoración naranja/negro
DR, automotore da manovra ASF, livrea arancione/nera
DR, locomotive de manoeuvre ASF, livrée orange/noire
DR, ASF shunting device, orange/black livery



das kleinste angetriebene Modell von ARNOLD



NEW

HN2640/HN2640D



DB AG, ASF (Akku-Schleppfahrzeug) in weiß-rotem ICE-Design

DB AG, vehículo de maniobras ASF, decoración blanco/rojo diseño ICE

DB AG, automotore da manovra ASF, livrea ICE bianco/rossa

DB AG, locomotive de manoeuvre ASF, livrée ICE blanche/rouge

DB AG, ASF shunting device in white/red ICE design

NEW



Akkuschleppfahrzeug ASF

Für Verschiebearbeiten in Wagenwerkstätten und Containeranlagen, zum Umsetzen von Lokomotiven ohne eigene Kraft oder zum Bewegen von Elektrolokomotiven ohne Fahrleitungen in Bahnbetriebswerken hat der Lokomotivbau Elektrotechnischen Werke (LEW) in Hennigsdorf ab 1966 die auf der bewährten Grubenlokomotive EL8 basierende erste Serie eines Akku-Schleppfahrzeuges an die Deutsche Reichsbahn ausgeliefert. Wegen der günstigen Anschaffungskosten, des geringen Wartungsaufwands und eines emissionsfreien Betriebs konnten und können die kleinen Rangierer universell verwendet werden und bewährten und bewähren sich gut.

Bis 1990 wurden 506 Fahrzeuge. Nachdem das ASF in der Anfangszeit Grundausrüstung in allen Bahnbetriebs- und Ausbesserungswerken der Deutschen Reichsbahn und in vielen Industriebetrieben in Ostdeutschland war, ist der kleine Rangierer nach Gründung der Deutschen Bahn AG auch in deren großen Werken deutschlandweit anzutreffen. Selbst in ICE-Instandhaltungswerken ist das ASF nunmehr, unter anderem auch mit klassischer ICE-Farbgebung, zu finden. Mit der Schließung von DB-Werken oder Industriebetrieben fanden viele ein neues Einsatzgebiet in anderen Werkstandorten, bei Privatbahnen oder Eisenbahnvereinen, nur wenige ASF wurden bisher verschrottet.

HN2657/HN2657S



NEW

-  **DB AG, diesel-elektrische Lokomotive 234 304-4, mintgrüne Farbgebung**
- DB AG, locomotora diésel-eléctrica 234 304-4, decoración verde menta
- DB AG, locomotiva diesel 234 304-4, livrea verde menta
- DB AG, locomotive diesel électrique 234 304-4, livrée vert menthe
- DB AG, diesel-electric locomotive 234 304-4, mint green livery

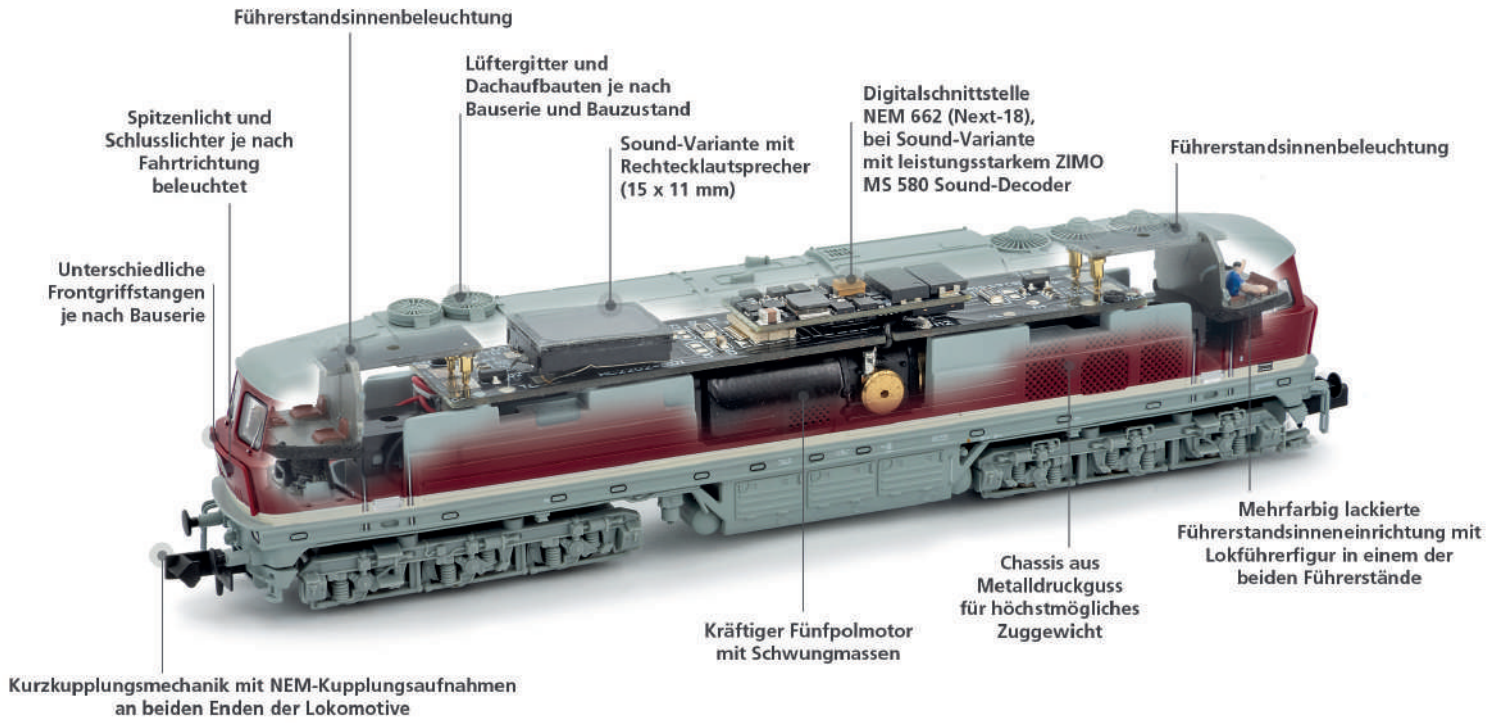
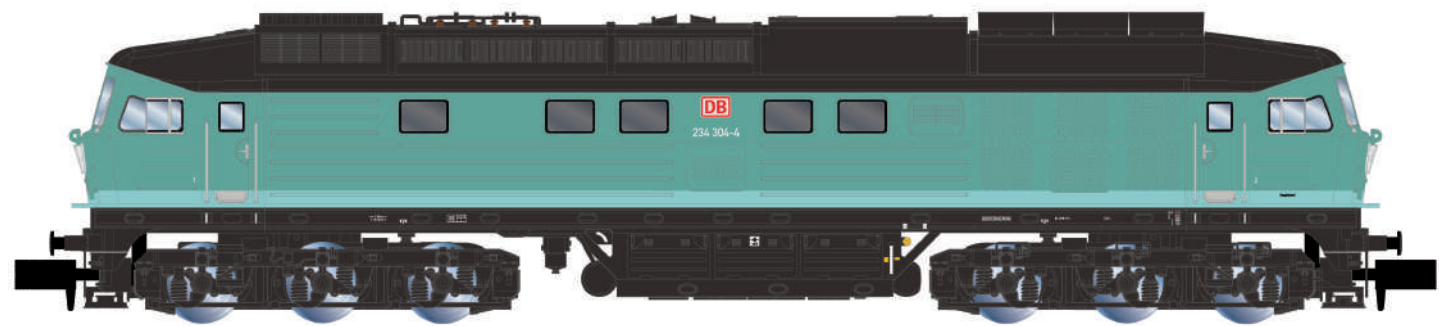

HN2658/HN2658S



NEW



DR, diesel-elektrische Lokomotive 132 089-4, rote Farbgebung mit grauem Dach

DR, locomotora diésel-eléctrica 132 089-4, decoración roja con techo gris

DR, locomotiva diesel 132 089-4, livrea rossa con tetto grigio

DR, locomotive diesel électrique 132 089-4, livrée rouge avec toit gris

DR, diesel-electric locomotive 132 089-4, red livery with grey roof



HN2659/HN2659S



NEW



DB Cargo, diesel-elektrische Lokomotive 232 573-6, Verkehrsrot Farbgebung

DB Cargo, locomotora diésel-eléctrica 232 573-6, decoración rojo tráfico

DB Cargo, locomotiva diesel 232 573-6, livrea rosso traffico

DB Cargo, locomotive diesel électrique 232 573-6, livrée rouge traffic

DB Cargo, diesel-electric locomotive 232 573-6, traffic red livery



HN2608/HN2608S

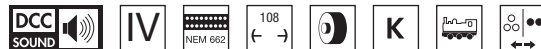

NEW



RENFE, Elektrolokomotive 269-078, grün/gelbe Farbgebung mit modernem „Wappenlogo“

RENFE, locomotora eléctrica 269-078, decoración verde/amarillo con escudo de logo
RENFE, locomotiva elettrica 269-078, livrea verde/giallo con logo moderno sul frontale
RENFE, locomotive électrique 269-078, livrée vert/jaune avec logo moderne à l'avant
RENFE, electric locomotive 269-078, green/yellow livery with modern badge front logos



Las locomotoras série 269

Las locomotoras serie de 269 fueron la tercera generación de locomotoras japonesas adquiridas por RENFE. Tras los buenos resultados de las series precedentes, los pedidos a Mitsubishi, fabricación en España, fueron ampliándose desde 1973 hasta mediados de los años 80, llegando a ser la serie de locomotoras más numerosas y con más variantes del parque motor español. Dotadas con una potencia de 3100 kW y una velocidad máxima de entre 140 y 160 km/h, han sido las indiscutibles reinas de la tracción eléctrica española durante años. Se dividen en múltiples subseries, cada una con sus particularidades tanto interiores como exteriores.

Características del modelo de Arnold

- Chasis en metal
- Motor de cinco polos con volantes de inercia
- Conector digital NEM 662, Next-18
- Pantógrafos metálicos detallados, con posición según versión
- Luces rojas y blancas independientes, según sentido de la marcha
- Radio mínimo 192 mm.
- Cinemática de enganche corto
- Versiones de carrocería, techo y bogies según época y decoración



Ventanas frontales y laterales
sin reformar



© I.M.Yunta

HN2610/HN2610S

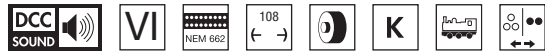

NEW



ALSA, Elektrolokomotive 269-413, weiß/blaue Farbgebung

- ALSA, locomotora eléctrica 269-413, decoración blanco/azul
- ALSA, locomotiva elettrica 269-413, livrea bianco/blu
- ALSA, locomotive électrique 269-413, livrée blanc/bleu
- ALSA, electric locomotive 269-413, white/blue livery



Bogies de alta velocidad aptos para 160km/h



HN2643/HN2643S

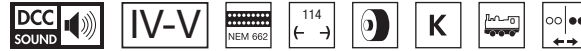

E 646

NEW



FS, Elektrolokomotive der Reihe E.646 „Navetta“, 2. Bauserie, Triplex-Fenstern, „MDVC“-Farbgebung mit silbernem Dach

FS, locomotora eléctrica E.646 “Navetta”, 2ª serie, ventanas Triplex, decoración “MDVC” con techo plateado

FS, locomotiva elettrica E.646 “Navetta”, 2ª serie, vetri Triplex, livrea “MDVC” con tetto argento

FS, locomotive électrique E.646 « Navetta », 2^{ème} série, fenêtres Triplex, livrée « MDVC » avec toit argenté

FS, electric locomotive E.646 “Navetta”, 2nd series, with Triplex windows and silver roof, “MDVC” livery

*Abb. zeigt Spur-H0 Modell /
L'immagine rappresenta il modello
in scala H0 /
Picture shows H0 scale model*



Nuova cassa per E646 “Navetta” con vetri “Triplex” e nuovi dettagli riportati su tetto e frontali

L'applicazione sulle E646 “Navetta” della nuova livrea beige con fasce arancio e viola detta MDVC (per riprendere la sigla delle carrozze su cui è stata introdotta) risale al 1981, inizialmente con rettangolo frontale arancio poi sostituito da “baffi” arancio e viola attorno al fregio FS. Nella seconda metà degli anni '80 il tetto viene dipinto in argento anziché l'originale grigio scuro, per migliorare la dissipazione del calore del reostato. Nello stesso periodo iniziano a diffondersi su queste macchine i vetri frontali corazzati “Triplex” con vistosa cornice alluminio, che alterano sensibilmente l'impatto visivo del frontale della macchina.



Photo: Pino Corrias



HN2644

HN6539

HN6539

HN2644/HN2644S

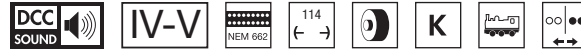

E 645

NEW



FS, Elektrolokomotive der Reihe E.645, 2. Bauserie, mit Triplex-Fenstern, Castano/Isabella-Farbgebung

FS, locomotora eléctrica E.645, 2ª serie, con ventanas Triplex, decoración Castano/Isabella

FS, locomotiva elettrica E.645, 2ª serie, con vetri Triplex, livrea castano/Isabella

FS, locomotive électrique E.645, 2ème série, avec fenêtres Triplex, livrée Castano/Isabella

FS, electric locomotive E.645, 2nd series, with Triplex windows, Castano/Isabella livery

*Abb. zeigt Spur-H0 Modell /
L'immagine rappresenta il modello
in scala H0 /
Picture shows H0 scale model*



Nuova cassa per E645 senza modanature e con vetri "Triplex" e nuovi dettagli riportati su tetto e frontali

Già a metà anni '70 sulle E646 ed E645 di seconda serie si iniziò a rimuovere le modanature alluminio, in alcuni casi causa di infiltrazioni d'acqua che andavano a danneggiare la cassa della macchina. Si diffuse quindi un nuovo schema di verniciatura per queste macchine, con la fascia scura originariamente tra le modanature che va ad allargarsi sui frontali e sui fanali, senza la marcatura in rilievo sotto al fregio FS ma mantenendo il resto della coloritura invariato. Anche le E645 a metà anni '80 iniziarono a ricevere i vetri frontali "Triplex", la cui cornice alluminio risaltava ancora di più sul castano della livrea.



HN6540

HN6540

HN6561

HN2624/HN2624S

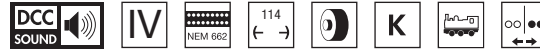

NEW



FS, schwere sechsachsige Elektrolokomotive der Reihe E.646 in grün-grauer Farbgebung mit Aluminiumzierstreifen, schwarzen Drehgestellen und großen Trittstufen

FS, locomotora eléctrica E.646, decoración verde/gris con franjas plata, bogies negros y peldaños grandes

FS, locomotiva elettrica gruppo E.646, livrea verde/grigia con modanature, carrelli neri, scalette grandi

FS, locomotive électrique classe E.646, livrée verte/grise avec enjoliveurs en aluminium, bogies noirs, grands marchepieds

FS, heavy articulated six-axle electric locomotive class E.646 in green/grey livery with aluminium embellishments, black bogies, big steps



Espresso 280 "Alpen-Express" Roma-München, periodo 1981-1984, con carrozze FS e DB

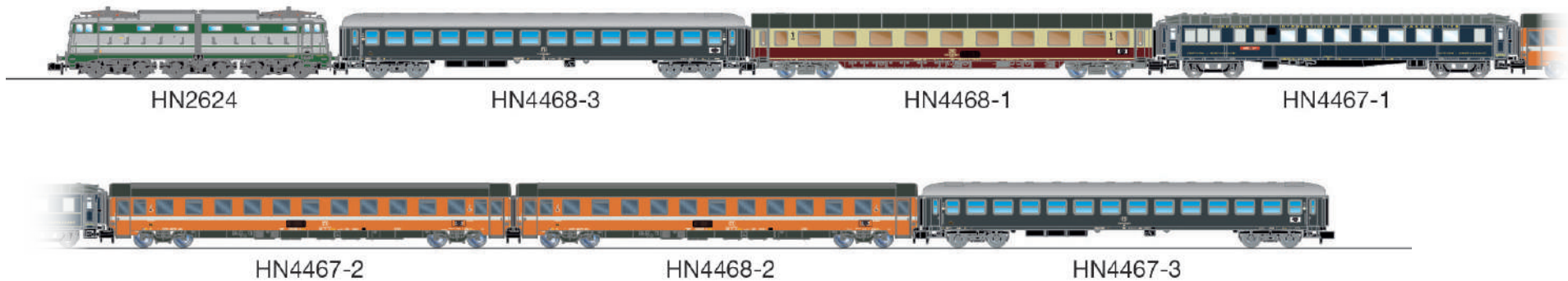

HN2623/HN2623S

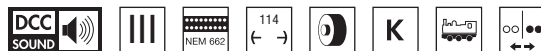

NEW



FS, schwere sechssachsige Elektrolokomotive der Reihe E.646 „Treno Azzurro“-Farbgebung

FS, locomotora eléctrica E.646, decoración “Treno Azzurro”

S, locomotiva elettrica gruppo E.646, livrea “Treno Azzurro”

FS, locomotive électrique classe E.646, livrée « Treno Azzurro »

FS, heavy articulated six-axle electric locomotive class E.646 in “Treno Azzurro” livery

HN2623/S in dettaglio

- Scalette anteriori strette
- Niente tromba
- Tergicristallo singolo di origine a sx del vetro
- Corrimani sul tetto corti solo sulla destra della cabina
- Prese d'aria di origine sulle fiancate
- Portelloni lato destro semicassa A piccoli



HN2625/HN2625S

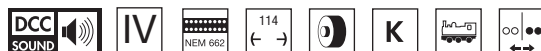

NEW



FS, schwere sechssachsige Elektrolokomotive der Reihe E.645 in „Castano/Isabella“-Farbgebung mit Aluminiumzierstreifen, schwarzen Drehgestellen und großen Trittstufen

FS, locomotora eléctrica E.645, decoración castaño/isabella con franjas plata, bogies negros y peldaños grandes

FS, locomotiva elettrica gruppo E.645, livrea “Castano/Isabella” con modanature, carrelli neri, scalette grandi

FS, locomotive électrique classe E.645, livrée « Castano/Isabella » avec enjoliveurs en aluminium, bogies noirs et grands marchepieds

FS, heavy articulated six-axle electric locomotive class E.645 in Castano/isabella livery with aluminium embellishments, black bogies and big steps

Caratteristiche tecniche dei modelli HN2624/S e HN2625/S

- Scalette anteriori larghe
- Con tromba
- Due tergicristalli sotto ai vetri frontali
- Corrimani sul tetto lunghi su entrambi i lati delle cabine
- Prese d'aria modificate sulle fiancate
- Portelloni lato destro semicassa A grandi rialzati



E.656.492



© Davide Porciello (Fondazione FS)

Le locomotive elettriche del Gruppo E656 rappresentano l'ultima evoluzione della grande famiglia di locomotive "articolate" delle FS, caratterizzate dallo schema meccanico a due semicasce poggianti su tre carrelli a due assi dotati ciascuno di due motori (doppi in questo caso), introdotto con le E636 nel 1940 e mantenuto fino alla produzione dell'ultima E656 nel 1989.

Le E656 sono state consegnate a partire dal 1975 per un totale di 461 unità, suddivise in sei serie con alcune differenze tecniche ed estetiche frutto dell'evoluzione del progetto durante la costruzione.

Grazie alla loro elevata potenza e alla velocità massima di 150 km/h, furono da subito destinate a rilevare i treni passeggeri a lunga percorrenza più importanti dell'epoca, treni di prestigio come alcuni TEE, ma anche treni diretti o locali con numerose fermate fino a pesanti merci al limite delle prestazioni, diventando rapidamente una delle colonne portanti del parco trazione FS. Nel 1976 sulla rivista "Voci della Rotaia" è stato indetto un concorso per scegliere un soprannome alla E656, e la proposta vincente è risultata "Caimano".

A partire dal 2010 è iniziata la graduale dismissione dal servizio regolare dell'intero gruppo; attualmente, grazie al lavoro di Fondazione FS, almeno 18 unità sono state preservate dalla demolizione e molte di queste, dopo ripristino funzionale ed estetico in livrea di origine, sono utilizzate regolarmente in testa a treni storici.

HN2645/HN2645S

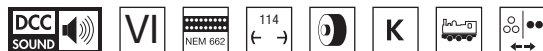

NEW

 **FS, Elektrolokomotive der Reihe E.656, 5. Bauserie, blau/grau-Farbgebung, „50. Jubiläumsausgabe“**

FS, locomotora eléctrica E.656, 5ª serie, decoración azul/gris, edición “50º Aniversario”

FS, locomotiva elettrica E.656, 5ª serie, livrea blu/grigio, edizione “50º Anniversario”

FS, locomotive électrique E.656, 5^{ème} série, livrée bleu/gris, édition « 50^{ème} Anniversaire »

FS, electric locomotive E.656, 5th series, blue/grey livery, “50th Anniversary” edition

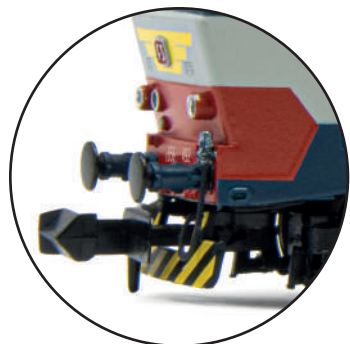

Fanaleria e dettagli frontali conformi alla E656 492 preservata per treni storici



Fotomontage / Fotomontaje / Fotomontaggio / Photomontage



Il prodotto viene preservato con una box celebrativa, con all'interno un libretto in edizione speciale e un portachiavi con riprodotto il frontale della locomotiva.

EDIZIONE CELEBRATIVA 50 ANNI E.656

La E656 492, rappresentante della quinta serie del gruppo E656, è una delle “fortunate” unità preservate grazie al lavoro di Fondazione FS. Nel corso del 2022 è stata interamente revisionata con relativo cambio carrelli nelle officine di Foligno, ricevendo nuovamente nell’occasione la classica livrea di origine grigio perla/blu orientale ed il famoso “caimano” sulla fiancata sinistra delle cabine.

Attualmente è regolarmente utilizzata in testa a treni storici su tutto il territorio italiano, come degna rappresentante del gruppo E656 che quest’anno festeggia i suoi primi 50 anni.

HN2646/HN2646S



NEW

 **FS, Elektrolokomotive der Reihe E.656, 2. Bauserie, mit Seitendämpfern, blau/grau-Farbgebung**

FS, locomotora eléctrica E.656, 2ª serie, con amortiguadores laterales, decoración azul/gris

FS, locomotiva elettrica E.656, 2ª serie, con smorzatori laterali, livrea blu/grigio

FS, locomotive électrique E.656, 2^{ème} série, avec amortisseurs latéraux, livrée bleu/gris

FS, electric locomotive E.656, 2nd series, with side dampers, blue/grey livery



Ambientazione anni '90 con smorzatori, senza condizionatori



Fotomontage / Fotomontaje / Fotomontaggio / Photomontage



HN2646

HN4393

HN2647/HN2647S

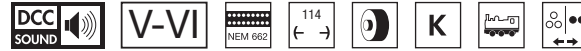

NEW

-  **FS, Elektrolokomotive der Reihe E.655, 4. Bauserie, „XMPR Cargo“-Farbgebung**
- FS, locomotora eléctrica E.655, 4ª serie, decoración “XMPR Cargo”
- FS, locomotiva elettrica E.655, 4ª serie, livrea “XMPR Cargo”
- FS, locomotive électrique E.655, 4^{ème} série, livrée « XMPR Cargo »
- FS, electric locomotive E.655, 4th series, “XMPR Cargo” livery



*Ambientazione anni 2000,
con vomere rosso*



Fotomontage / Fotomontaje / Fotomontaggio / Photomontage



HN4393

HN4393



HN2650/HN2650S



NEW

- SNCF, Elektrolokomotive CC 6502 „Mistral“ in silberner Ursprungsfarbgebung**
- SNCF, locomotora eléctrica CC 6502 “Mistral”, decoración original plateada
- SNCF, locomotiva elettrica CC 6502 “Mistral”, livrea d’origine argento
- SNCF, locomotive électrique CC 6502 « Mistral », livrée d’origine argent
- SNCF, electric locomotive CC 6502 “Mistral”, original silver livery



Fotomontage / Fotomontaje / Fotomontaggio / Photomontage



HN2650

HN4500

HN4503

HN2649/HN2649S



SNCF, elektrische Mehrsystemlokomotive CC 21003, silberne Farbgebung

SNCF, locomotora eléctrica bitensión CC 21003, decoración plateada
SNCF, locomotiva elettrica bicorrente CC 21003, livrea argento
SNCF, locomotive électrique bicourant CC 21003, livrée argent
SNCF, electric two-system locomotive CC 21003, silver livery



NEW

Fotomontage / Fotomontaje / Fotomontaggio / Photomontage

HN2648/HN2648S

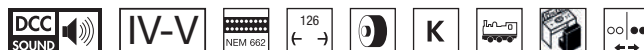

SNCF, elektrische Mehrsystemlokomotive CC 21002, „Béton“-Farbgebung mit „Beffara“-Logo

SNCF, locomotora eléctrica bitensión CC 21002, decoración gris “Béton” con logotipo “Beffara”
SNCF, locomotiva elettrica bicorrente CC 21002, livrea grigio “Béton” con logo “Beffara”
SNCF, locomotive électrique bicourant CC 21002, livrée gris « Béton » (logo « Beffara »)
SNCF, electric two-system locomotive CC 21002, beton grey livery with “Beffara” logo



NEW

Fotomontage / Fotomontaje / Fotomontaggio / Photomontage

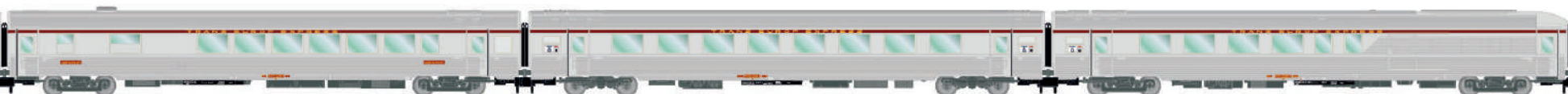

HN4500

HN4502

HN4500

HN2612/HN2612S



DB AG, achttelliger Hochgeschwindigkeitszug „ICE 3“ der Baureihe 403 im neuen Re-Design

DB AG, tren de alta velocidad “ICE3” serie 403, de 8 unidades, decoración nuevo rediseño

DB AG, set di 8 unità, treno ad alta velocità “ICE 3”, classe 403, nuova livrea

DB AG, coffret de 8 unités du train à grande vitesse « ICE 3 », classe 403, nouvelle livrée

DB AG, 8-unit high-speed train “ICE 3” class 403 in new re-design livery



Fotomontage / Fotomontaje / Fotomontaggio / Photomontage

HN2611/HN2611S



RENFE, AVE S-103, blau-weiße Originalfarbgebung

RENFE, tren de alta velocidad S-103, decoración azul/blanco original

RENFE, AVE S-103, livrea blue e bianco di origine

RENFE, AVE S-103, livrée bleue-blanche d'origine

RENFE, AVE S-103, blue-white original livery

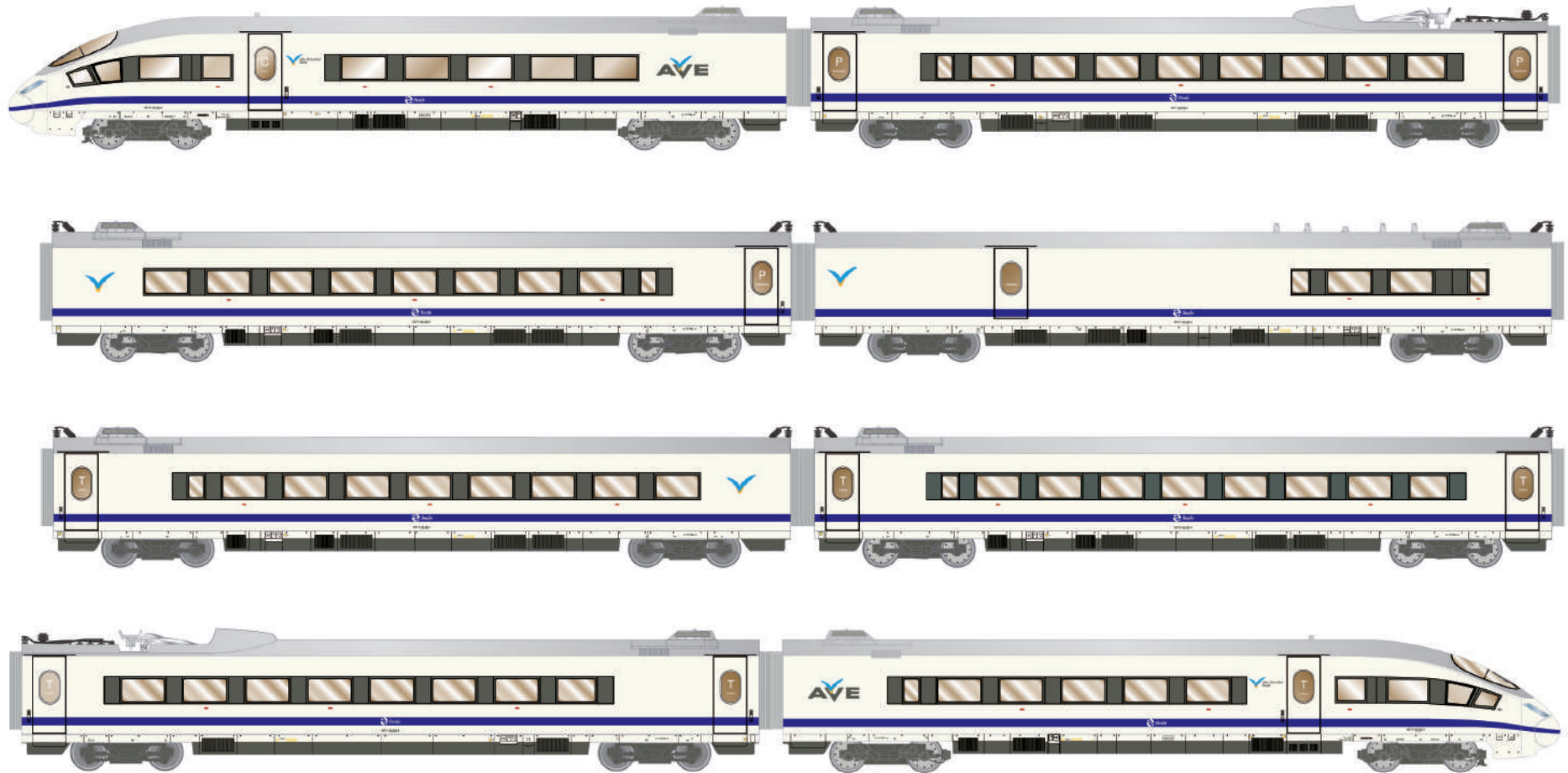



RENFE

444



HN2616/HN2616D/HN2616S



NEW



RENFE, elektrischer Triebzug der Reihe 444, Triebzug 444-004 in rot-gelber Farbgebung

RENFE, automotor eléctrico serie 444, unidad 444-004, decoración rojo/amarillo

RENFE, elettromotrice serie 444, unità 444-004, livrea d'origine rossa/gialla

RENFE, automotrice électrique classe 444, numéro d'immatriculation 444-004, livrée rouge/jaune

RENFE, 3-unit EMU class 444, unit 444-004 in original red/yellow livery

Pantógrafos metálicos

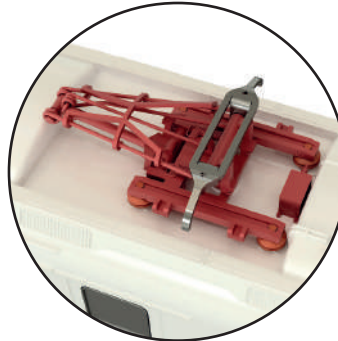

Características HN2616/D/S

- Versión de origen
- Testeros con puertas de intercomunicación
- Decoración rojo/amarillo
- Desde 1980 a 1993

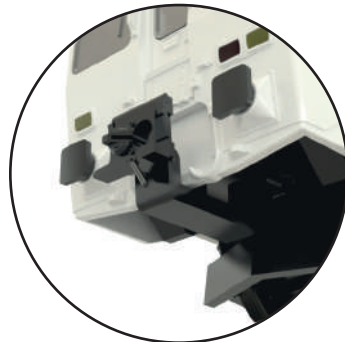

Enganche frontal intercambiable,
decorativo



Enganche frontal intercambiable,
funcional

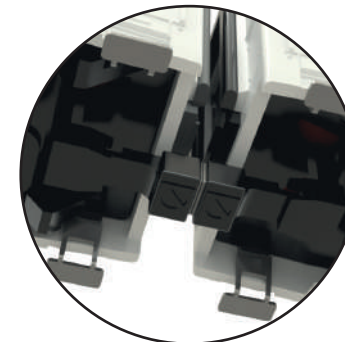

Enganches magnéticos ARNOLD
para todas las referencias
(ver también la sección "Accesorios, HC8063)

HN2617/HN2617D/HN2617S



NEW



RENFE, elektrischer Triebzug der Reihe 444-500, Triebzug 444-503 in „Estrella“-Farbgebung

RENFE, automotor eléctrico serie 444.5, unidad 444-503, decoración "Estrella"

RENFE, elettromotrice serie 444.5, unità 444-503, livrea «Estrella»

RENFE, automotrice électrique classe 444.5, numéro d'immatriculation 444-503, livrée « Estrella »

RENFE, 3-unit EMU class 444-500, unit 444-503 in "Estrella" livery

Características HN2616/D/S

- Decoración "Estrella"
- Desde 1987 a 1994



Parte frontal fiel a la realidad, reproducida con todo detalle

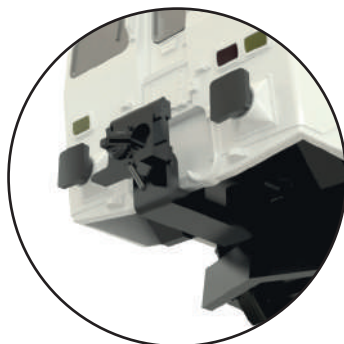

Enganche frontal intercambiable, decorativo



Enganche frontal intercambiable, funcional



I. Martín Yunta

HN2618/HN2618D/HN2618S

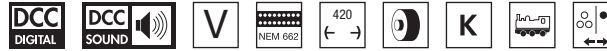

NEW



RENFE, elektrischer Triebzug der Reihe 444, Triebzug 444-011 in blau-weißer Farbgebung

RENFE, automotor eléctrico serie 444, unidad 444-011, decoración azul/blanca

RENFE, elettromotrice serie 444, unità 444-011, livrea blu/bianca

RENFE, automotrice électrique classe 444, numéro d'immatriculation 444-011, livrée bleue/blanche

RENFE, 3-unit EMU class 444, unit 444-011 in blue-white livery

Características HN2618/D/S

- Testeros con puertas de intercomunicación
- Decoración azul/blanco
- Desde 1990 a 1994

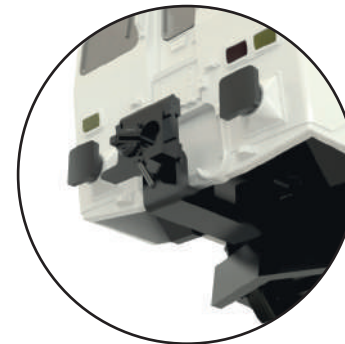

Enganche frontal intercambiable,
decorativo

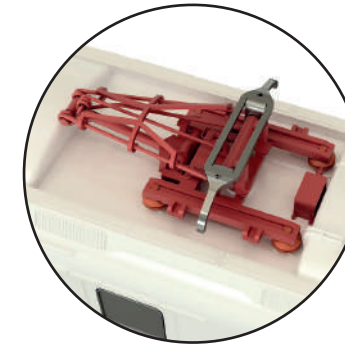

Pantógrafos metálicos

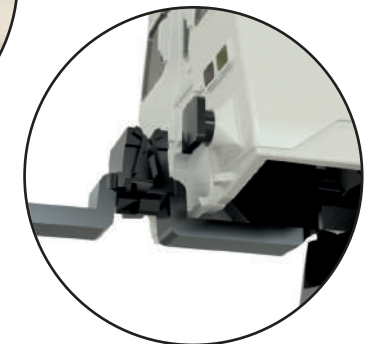

Enganche frontal intercambiable,
funcional

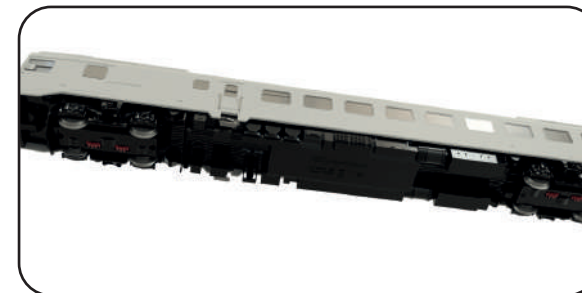

Chasis metálico para el coche motor



J. Martín Yunta

FRECCIAROSSA 1000



- Modello interamente nuovo
- Unità di testa motorizzata con trasmissione su tutti gli assi, unità di coda folle con funzioni luci
- Tre fanali di testa bianchi e due di coda rossi in base alla direzione di marcia come al vero, fanali di profondità con comando indipendente
- Unità motorizzata con presa decoder
- "Next18" NEM 662 e predisposizione per altoparlante "sugar cube" 11x15 mm, unità folle con presa decoder "Next18" NEM 662 per decoder funzioni
- Versioni digitali con decoder DCC Sound + Fx ed altoparlante installati di serie
- Riproduzione completa delle apparecchiature sul tetto
- Riproduzione completa delle carenature davanti ai carrelli
- Parte terminale della carenatura frontale rimovibile, con possibilità di installazione di una barra rigida per formare trazioni multiple con due elettrotreni
- Carrelli delle carrozze differenziati tra elementi motrici o rimorchiati (al vero)
- Aggancio corto tra le carrozze
- Mantici tra le carrozze molleggiati per un'ottimale continuità visiva del treno
- Raggio minimo di curvatura: 192 mm



Frecciarossa 1000

Il Frecciarossa 1000, nome commerciale dell'ETR 1000 (Elettrotreno Rapido) nella classificazione FS, è il più moderno treno ad alta velocità del parco Trenitalia.

È stato co-sviluppato come una joint venture tra il produttore ferroviario italiano Ansaldo Breda (ora Hitachi Rail Italy) e il conglomerato multinazionale Bombardier Transportation. Sia il lavoro di progettazione che quello di produzione sono stati divisi tra le due aziende partner. Il progetto del veicolo, formalmente denominato Zefiro 300, è stato presentato dalla joint venture in risposta alla gara delle Ferrovie dello Stato per 50 nuovi treni ad alta velocità.

Le specifiche iniziali prevedevano un treno conforme agli standard tecnici europei per l'alta velocità, con una velocità commerciale di progetto di 360 km/h (220 mph), inizialmente operato a 300 km/h (190 mph) e da testare a 400 km/h (250 miglia all'ora).

Altri requisiti specificavano che il treno fosse adatto a un programma di manutenzione predittiva basato sulle condizioni, oltre alla possibilità di essere utilizzato in otto diversi paesi europei, in particolare i sistemi ferroviari di Italia, Francia, Germania, Austria, Belgio, Paesi Bassi, Spagna e Svizzera. I servizi commerciali del nuovo treno sono iniziati nel mese di giugno 2015, in occasione di Expo 2015.

L'introduzione dell'ETR 1000 consentirà a Trenitalia di ridistribuire i precedenti treni ad alta velocità ETR 500 su altre tratte, come Milano – Venezia e la costa adriatica.



Composizione del treno / Composition du train / Zugbildung / Train composition

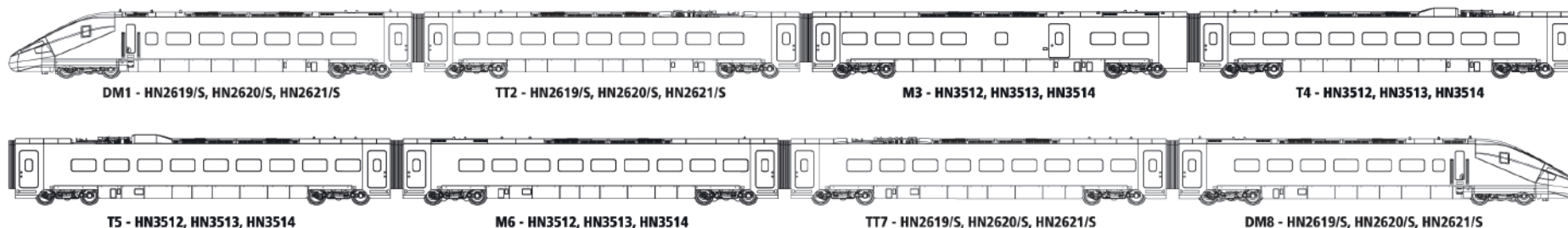

HN2619/HN2619D/HN2619S

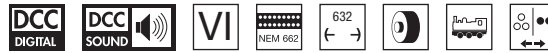

NEW

FS Trenitalia, 4-tlg. Grundset des Hochgeschwindigkeitszugs „Frecciarossa 1000“, in neuer Farbgebung

FS Trenitalia, set base de 4 unidades del tren de alta velocidad “Frecciarossa 1000” en nueva decoración

FS Trenitalia, set base di 4 unità del treno ad alta velocità “Frecciarossa 1000”, nuova livrea

FS Trenitalia, coffret principal de 4 unités du train à grande vitesse « Frecciarossa 1000 », nouvelle livrée

FS Trenitalia, 4-unit base set of the high-speed train “Frecciarossa 1000”, new livery



HN3512

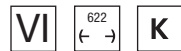

NEW

FS Trenitalia, 4-tlg. Set Zwischenwagen des Frecciarossa ETR 1000, in neuer Farbgebung

FS Trenitalia, set de 4 coches intermedios de Frecciarossa ETR 1000 en nueva decoración

FS Trenitalia, set aggiuntivo di 4 unità del treno ad alta velocità “Frecciarossa 1000”, nuova livrea

FS Trenitalia, coffret de 4 voitures intermédiaires supplémentaires du train à grande vitesse « Frecciarossa 1000 », nouvelle livrée

FS Trenitalia, 4-unit intermediate coaches set of the high-speed train “Frecciarossa 1000”, new livery



HN2620/HN2620D/HN2620S



NEW

FS Trenitalia, 4-tlg. Grundset des Hochgeschwindigkeitszugs „Frecciarossa 1000“, mit „Ducati“-Werbung

FS Trenitalia, set base de 4 unidades del tren de alta velocidad "Frecciarossa 1000", con publicidad "Ducati"

FS Trenitalia, set base di 4 unità del treno ad alta velocità "Frecciarossa 1000", livrea pubblicitaria "Ducati"

FS Trenitalia, coffret principal de 4 unités du train à grande vitesse « Frecciarossa 1000 », livrée avec publicité « Ducati »

FS Trenitalia, 4-unit base set of the high-speed train "Frecciarossa 1000", "Ducati" advertising



HN3513

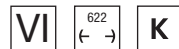

NEW

FS Trenitalia, 4-unit intermediate coaches set of the high-speed train "Frecciarossa 1000", "Ducati" publicity

FS Trenitalia, set de 4 coches intermedios de Frecciarossa ETR 1000 en decoración "Ducati"

FS Trenitalia, set aggiuntivo di 4 unità del treno ad alta velocità "Frecciarossa 1000", livrea pubblicitaria "Ducati"

FS Trenitalia, coffret de 4 voitures intermédiaires supplémentaires du train à grande vitesse « Frecciarossa 1000 », livrée avec publicité « Ducati »

FS Trenitalia, 4-unit intermediate coaches set of the high-speed train "Frecciarossa 1000", "Ducati" advertising



HN2621/HN2621D/HN2621S

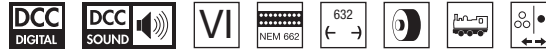

NEW



FS Trenitalia, 4-tlg. Grundset des Hochgeschwindigkeitszugs „Frecciarossa 1000“, mit „Le plaisir d'un voyage nouveau“-Werbung

FS Trenitalia, set base de 4 unidades del tren de alta velocidad "Frecciarossa 1000", en decoración "Le plaisir d'un voyage nouveau"

FS Trenitalia, set base di 4 unità del treno ad alta velocità "Frecciarossa 1000", livrea pubblicitaria "Le plaisir d'un voyage nouveau"

FS Trenitalia, coffret principal de 4 unités du train à grande vitesse « Frecciarossa 1000 », livrée avec publicité « Le plaisir d'un voyage nouveau »

FS Trenitalia, 4-unit base set of the high-speed train "Frecciarossa 1000", "Le plaisir d'un voyage nouveau" advertising



HN3514

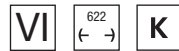

NEW



FS Trenitalia, 4-tlg. Set Zwischenwagen des Frecciarossa ETR 1000, in „Le plaisir d'un voyage nouveau“ Farbgebung

FS Trenitalia, set de 4 coches intermedios de Frecciarossa ETR 1000 en decoración "Le plaisir d'un voyage nouveau"

FS Trenitalia, set aggiuntivo di 4 unità del treno ad alta velocità "Frecciarossa 1000", livrea pubblicitaria "Le plaisir d'un voyage nouveau"

FS Trenitalia, coffret de 4 voitures intermédiaires supplémentaires du train à grande vitesse « Frecciarossa 1000 », livrée avec publicité « Le plaisir d'un voyage nouveau »

FS Trenitalia, 4-unit intermediate coaches set of the high-speed train "Frecciarossa 1000", "Le plaisir d'un voyage nouveau" advertising



iryo



© Chenchó Ruíz

IRYO el Frecciarossa español

Tras la liberación del sector ferroviario español llegó la competencia en varios trayectos ferroviarios. Entre las nuevas empresas que obtuvieron licencia de operador y los consiguientes surcos de operación para sus trenes.

Iryo es una marca que nace bajo el paraguas de ILSA, un consorcio integrado por Air Nostrum y Trenitalia. El objetivo de la marca ha sido ofrecer una alternativa más barata que el resto de opciones de alta velocidad en España.

Iryo ofrece sus servicios a los viajeros de Madrid, Zaragoza, Barcelona, Valencia, Cuenca, Alicante, Córdoba, Málaga, Sevilla, Albacete y Antequera.

El tren ETR 1000 fabricado por el consorcio Hitachi-Bombardier (ahora grupo Alstom), es el tren más rápido, moderno y sostenible en Europa. Gracias a un diseño aerodinámico de última generación y el uso de tecnologías de ahorro de energía, consigue llegar hasta los 360 kilómetros por hora de forma muy eficiente. Además de silencioso, cuenta con una capacidad para 419 pasajeros.

Este tren de Alta Velocidad ofrece el mayor nivel de confort en España. Con servicios como conexión WiFi 5G de máxima calidad y área de restauración, hacen del Frecciarossa 1000, como es conocido en Italia, el mejor tren del mercado español.



HN2622/HN2622D/HN2622S



NEW



Iryo, 4-tlg. Grundset des Hochgeschwindigkeitszugs „Frecciarossa 1000“

Iryo, set base de 4 unidades del tren de alta velocidad “Frecciarossa 1000”

Iryo, set base di 4 unità del treno ad alta velocità “Frecciarossa 1000”

Iryo, coffret principal de 4 unités du train à grande vitesse « Frecciarossa 1000 »

Iryo, 4-unit base set of the high-speed train “Frecciarossa 1000”



HN3515

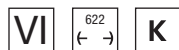

NEW



FS Trenitalia, 4-tlg. Set Zwischenwagen des Frecciarossa ETR 1000

FS Trenitalia, set de 4 coches intermedios de Frecciarossa ETR 1000

Iryo, set aggiuntivo di 4 unità del treno ad alta velocità “Frecciarossa 1000”

Iryo, coffret de 4 voitures intermédiaires supplémentaires du train à grande vitesse « Frecciarossa 1000 »

Iryo, 4-unit set of intermediate coaches for the high-speed train “Frecciarossa 1000”



HN4387

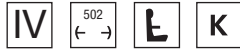

NEW



DB, 3-tlg. Set TEE-Wagen „Rembrandt“, bestehend aus 1 x Speisewagen ARmz²¹⁷ + 1 x Apmz¹²² + 1 x Avmz²⁰⁷

DB, set de 3 coches TEE “Rembrandt”, compuesto por 1 x coche restaurante ARmz²¹⁷ + 1 x Apmz¹²² + 1 x Avmz²⁰⁷

DB, set di 3 carrozze TEE “Rembrandt”, composto da 1 x ARmz²¹⁷ + 1 x Apmz¹²² + 1 x Avmz²⁰⁷

DB, set de 3 voitures TEE « Rembrandt », composé de 1 x voiture restaurant ARmz²¹⁷ + 1 x Apmz¹²² + 1 x Avmz²⁰⁷

DB, 3-unit set of TEE coaches “Rembrandt”, consisting of 1 x restaurant coach ARmz²¹⁷ + 1 x Apmz¹²² + 1 x Avmz²⁰⁷

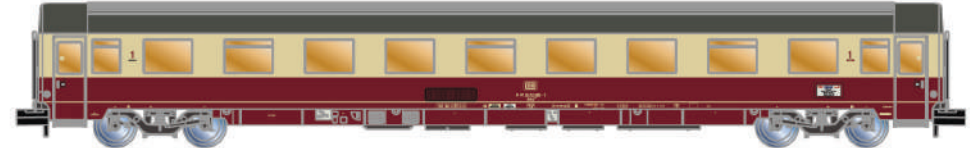

TEE „Rembrandt“

Der TEE 11/12 „Rembrandt“ wurde am 28.05.1967 in der Relation München - Amsterdam der Pendant zum TEE „Rheingold“. Namensgeber war der holländische Barockmaler und Künstler Rijn van Rembrandt.

Der TEE 11, der frühmorgens mit zwei, am Vorabend von TEE „Blauer Enzian“ abgestellten Reisezugwagen (1 Avm, 1 Apm) und einem Speisewagen WRm in München startete, machte in Stuttgart Kopf und erreichte Mannheim mit dem Speisewagen an der Zugspitze, wo die beiden Kurswagen vom TEE „Helvetia“ mitsamt der Zuglok vorne angekoppelt wurden. In Emmerich wurden der von Zürich kommende Abteilwagen Avm an der Zugspitze und der Münchner Avm Schlusswagen abgehängt und der noch aus einem Avm, 1 WRm und 1 Apm.

Diese drei Wagen wurden nach Reinigungsarbeiten, in umgekehrter Reihung, wieder von der gleichen Lokomotive im TEE 36 „Rhein-Main“ nach Emmerich gefahren, nahmen dort die beiden abgestellten Avm an die Zugspitze, und machten sich bespannt von BR 112 auf den Weg nach Frankfurt/M. Dort, spätabends um 22.53 Uhr angekommen, kehrte der TEE 35 nach nächtlichen Säuberungsarbeiten frühmorgens in entgegengesetzter Reihung nach Amsterdam (Ankunft 12.19 Uhr) zurück, wobei er natürlich bei dem Halt in Emmerich die zwei Schlusswagen Avm abstellte.



HN4504

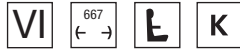

NEW



DB AG, 4-tlg. Set IC „Wavel“ Hamburg – Berlin – Krakau, bestehend aus 1 x Avmz + 1 x ARmz²¹⁸ + 2 x Bpmz, „ICE“-Farbgebung

DB AG, set de 4 coches IC “Wavel” Hamburgo – Berlin – Cracovia, compuesto por 1 x Avmz + 1 x ARmz²¹⁸ + 2 x Bpmz, decoración “ICE”

DB AG, set di 4 carrozze IC “Wavel Amburgo” – Berlino – Cracovia, composto da 1 x Avmz + 1 x ARmz²¹⁸ + 2 x Bpmz, livrea “ICE”

DB AG, set de 4 voitures IC « Wavel » Hambourg – Berlin – Cracovie, composé de 1 x Avmz + 1 x ARmz²¹⁸ + 2 x Bpmz, livrée « ICE »

DB AG, 4-unit set of IC “Wavel” Hamburg – Berlin – Krakow, consisting of 1 x Avmz + 1 x ARmz²¹⁸ + 2 x Bpmz, “ICE” livery

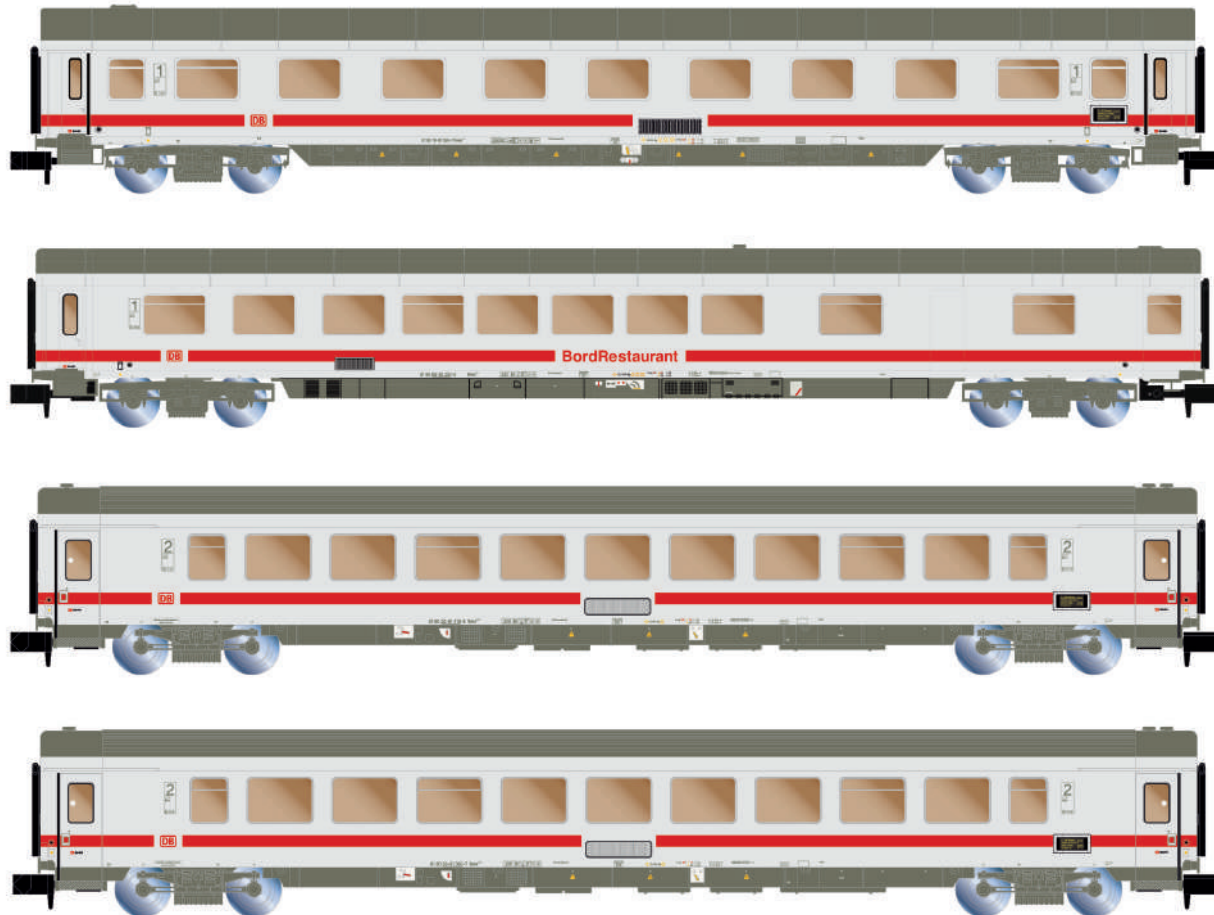

HN4507



NEW



AKE, 3-tlg. Set „Rheingold“, Set 1/2, bestehend aus 1 x Aussichtswagen ARDm + 1 x Clubwagen WGmh + 1 x Wagen Avmz

AKE, set de 3 coches “Rheingold”, set 1/2, compuesto por 1 x coche panorámico ARDm + 1 x coche club WGmh + 1 x coche Avmz

AKE, set di 3 carrozze “Rheingold”, set 1/2, composto da 1 x ARDm + 1 x WGmh + 1 x Avmz

AKE, coffret de 3 voitures « Rheingold », coffret 1/2, composé de 1 x voiture panoramique ARDm + 1 x voiture club WGmh + 1 x voiture Avmz

AKE, 3-unit set of “Rheingold”, set 1/2, consisting of 1 x observation car ARDm + 1 x club coach WGmh + 1 x coach Avmz



HN4508

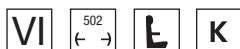

NEW



AKE, 3-tlg. Set „Rheingold“, Set 2/2, bestehend aus 1 x Speisewagen ARmh²¹⁷ + 1 x 1. Klasse Wagen Avmz + 1 x Wagen Apmz

AKE, set de 3 coches “Rheingold”, set 2/2, compuesto por 1 x coche restaurante ARmh²¹⁷ + 1 x coche de 1ª clase Avmz + 1 x coche Apmz

AKE, set di 3 carrozze “Rheingold”, set 2/2, composto da 1 x carrozza ristorante ARmh²¹⁷ + 1 x carrozza di prima classe Avmz + 1 x carrozza Apmz

AKE, coffret de 3 voitures « Rheingold », coffret 2/2, composé de 1 x voiture-restaurant ARmh²¹⁷ + 1 x voiture de 1^{ère} classe Avmz + 1 x voiture Apmz

AKE, 3-unit set of “Rheingold”, set 2/2, consisting of 1 x restaurant coach ARmh²¹⁷ + 1 x 1st class coaches Avmz + 1 x coach Apmz



HN4377

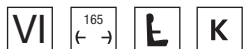

RailAdventure/LUXON, 4-achs. Aussichtswagen, in grauer Farbgebung

RailAdventure/LUXON, coche panorámico de 4 ejes, decoración gris

RAILADVENTURE/LUXON, carrozza panoramica a 4 assi, livrea grigia

RAILADVENTURE/LUXON, voiture panoramique à 4 essieux, livrée grise

RailAdventure/LUXON, 4-axle domecar, grey livery



HN4474

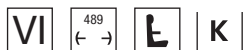

SNCF, 3-tlg. Set „Train Expo“, Set Nr. 3, 2 x T2-Schlafwagen + Barwagen

SNCF, set de 3 coches “Train Expo”, compuesto de dos coches cama tipo T2 y un bar

SNCF, set di 3 carrozze “Train Expo”, set n. 3, 2 carrozze letto T2 + carrozza bar

SNCF, coffret de 3 voitures « Train Expo », coffret n° 3, 2 x T2 voiture-lits + voiture-bar

SNCF, 3-unit pack “Train Expo”, set no. 3, 2 x T2 sleeping coach + bar coach



ÉTOILE du NORD

1927-1939

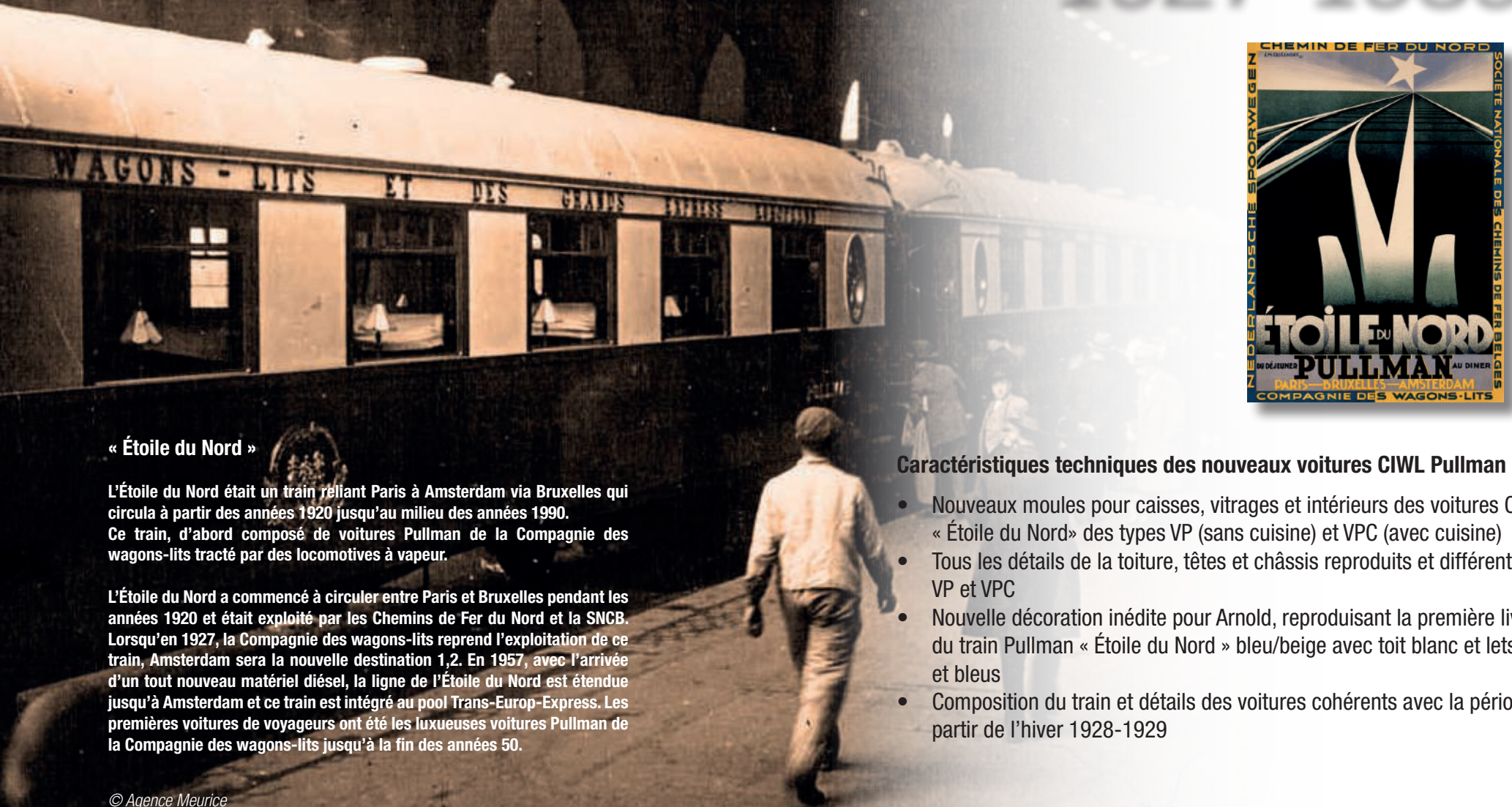

« Étoile du Nord »

L'Étoile du Nord était un train reliant Paris à Amsterdam via Bruxelles qui circula à partir des années 1920 jusqu'au milieu des années 1990.

Ce train, d'abord composé de voitures Pullman de la Compagnie des wagons-lits tracté par des locomotives à vapeur.

L'Étoile du Nord a commencé à circuler entre Paris et Bruxelles pendant les années 1920 et était exploité par les Chemins de Fer du Nord et la SNCB. Lorsqu'en 1927, la Compagnie des wagons-lits reprend l'exploitation de ce train, Amsterdam sera la nouvelle destination 1,2. En 1957, avec l'arrivée d'un tout nouveau matériel diesel, la ligne de l'Étoile du Nord est étendue jusqu'à Amsterdam et ce train est intégré au pool Trans-Europ-Express. Les premières voitures de voyageurs ont été les luxueuses voitures Pullman de la Compagnie des wagons-lits jusqu'à la fin des années 50.

Caractéristiques techniques des nouvelles voitures CIWL Pullman

- Nouveaux moules pour caisses, vitrages et intérieurs des voitures CIWL « Étoile du Nord » des types VP (sans cuisine) et VPC (avec cuisine)
- Tous les détails de la toiture, têtes et châssis reproduits et différents entre VP et VPC
- Nouvelle décoration inédite pour Arnold, reproduisant la première livrée du train Pullman « Étoile du Nord » bleu/beige avec toit blanc et lents dorés et bleus
- Composition du train et détails des voitures cohérents avec la période à partir de l'hiver 1928-1929

© Agence Meurice

HN4488

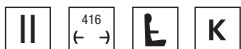

NEW

 **CIWL, 3-tlg. Zugpackung „Étoile du Nord“, Set 1/2, bestehend aus 1 x DD3, 1 x VP Flèche d’Or und 1 x VPC Étoile du Nord**

 CIWL, primer set de 3 coches “Étoile du Nord”, compuesto de un coche DD3, un VP “Flèche d’Or” y un VPC “Étoile du Nord”

 CIWL, set di 3 carrozze “Étoile du Nord”, set 1/2 (DD3, VP Flèche d’Or + VPC Étoile du Nord)

 CIWL, coffret de 3 unités « Étoile du Nord », set 1/2 (DD3, VP Flèche d’Or + VPC Étoile du Nord)

 CIWL, 3-unit pack “Étoile du Nord”, set 1/2 (DD3, VP Flèche d’Or + VPC Étoile du Nord)

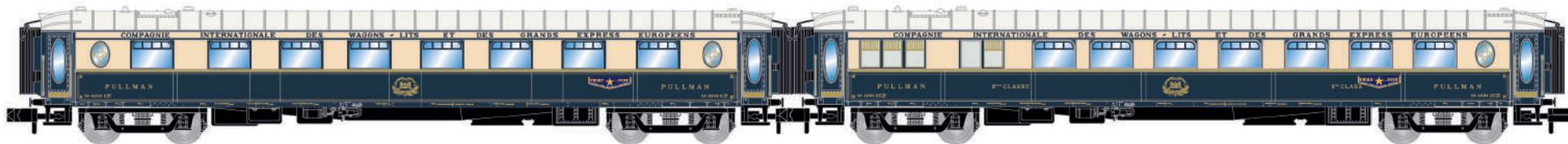

HN4489

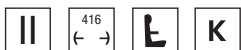

NEW

 **CIWL, 3-tlg. Zugpackung „Étoile du Nord“, Set 2/2, bestehend aus 1 x DD3, 1 x VPC Flèche d’Or und 1 x VP Étoile du Nord**

 CIWL, segundo set de 3 coches “Étoile du Nord”, compuesto de un coche DD3, un VPC “Flèche d’Or” y un VP “Étoile du Nord”

 CIWL, set di 3 carrozze “Étoile du Nord”, set 2/2 (DD3, VPC Flèche d’Or + VP Étoile du Nord)

 CIWL, coffret de 3 unités « Étoile du Nord », set 2/2 (DD3, VPC Flèche d’Or + VP Étoile du Nord)

 CIWL, 3-unit pack “Étoile du Nord”, set 2/2 (DD3, VPC Flèche d’Or + VP Étoile du Nord)

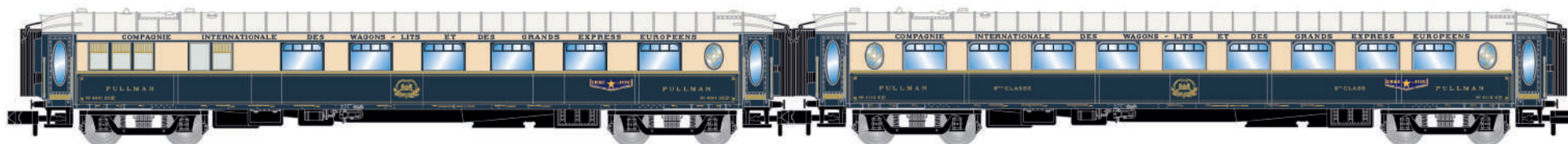



Pullman-Edelweiss-Zug Bahnhof Basel. 1937.

@ Wagons-Lits Diffusion

Der „Edelweiss“ verkehrte von 1928 bis 1979 mit kriegsbedingter Unterbrechung als Zugpaar zwischen der Schweiz und den Niederlanden über das Elsass und Luxemburg. Bis 1939 verkehrte der Zug als von der Internationalen Schlafwagensgesellschaft CIWL betriebener Luxuszug von Amsterdam nach Basel und zweitweise auch Luzern. Nach dem Zweiten Weltkrieg zunächst als normaler Schnellzug geführt,

wurde der Edelweiss ab 1957 eines der ersten Zugpaare des neuen Trans-Europ-Express-Systems (TEE). 1979 wurde er eingestellt. Wenig bekannt ist, dass der Edelweiss Pullman Express der CIWL damals ein direkter Konkurrent des damaligen Rheingolds war. Bis zum Kriegsausbruch verkehrte der Zug südlich von Basel aber auch zusammen mit den Kurswagen des Rheingolds.

Die CIWL setzte im „Edelweiss“ bis 1939 als Fahrzeuge ausschließlich ihre ab 1925 beschafften Pullmanwagen ein. Da diese mit Küche und Am-Platz-Service ausgestattet waren, gab es in der Regel keinen gesonderten Speisewagen und darüber hinaus nur Gepäckwagen. Als Tageszug führte der Edelweiss keine Schlafwagen mit. Im Regelfall bestand der „Edelweiss“ aus mindestens vier Pullmanwagen sowie zwei Gepäckwagen.

HN4490

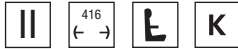

NEW



CIWL, 3-tlg. Zugpackung „Edelweiss Pullman Express“, Set 1/2, bestehend aus 1 x DD3, 1 x VPC Flèche d’Or und 1 x VP Étoile du Nord

CIWL, primer set de 3 coches “Edelweiss Pullman Express”, compuesto de un coche DD3, un VPC “Flèche d’Or” y un VP “Étoile du Nord”

CIWL, set di 3 carrozze “Edelweiss Pullman Express”, set 1/2 (DD3, VPC Flèche d’Or + VP Étoile du Nord)

CIWL, coffret de 3 unités « Edelweiss Pullman Express », set 1/2 (DD3, VPC Flèche d’Or + VP Étoile du Nord)

CIWL, 3-unit pack “Edelweiss Pullman Express”, set 1/2 (DD3, VPC Fleche d’or+ VP Étoile du Nord)



*Fotomontage / Fotomontaje /
Fotomontaggio / Photomontage*



HN4491

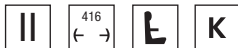

NEW



CIWL, 3-tlg. Zugpackung „Edelweiss Pullman Express“, Set 2/2, bestehend aus 1 x DD3, 1 x VPC Flèche d’Or und 1 x VP Étoile du Nord

CIWL, primer set de 3 coches “Edelweiss Pullman Express”, compuesto de un coche DD3, un VPC “Flèche d’Or” y un VP “Étoile du Nord”

CIWL, set di 3 carrozze “Edelweiss Pullman Express”, set 2/2 (DD3, VPC Flèche d’Or + VP Étoile du Nord)

CIWL, 3-tlg. Zugpackung „Edelweiss Pullman Express“, Set 2/2, bestehend aus 1 x DD3, 1 x VPC Flèche d’Or und 1 x VP Étoile du Nord

CIWL, 3-unit pack “Edelweiss Pullman Express”, set 2/2 (DD3, VPC Flèche d’Or + VP Étoile du Nord)



*Fotomontage / Fotomontaje /
Fotomontaggio / Photomontage*



HN4498

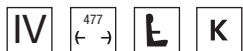

NEW



SNCF, 3-tlg. Set klimatisierter Reisezugwagen der Bauart „Mistral ‘69“, TEE „Jules Verne“

SNCF, set de 3 coches climatizados tipo Mistral ‘69, TEE “Jules Verne”

SNCF, set di 3 carrozze tipo “Mistral 69” TEE “Jules Verne”

SNCF, coffret de 3 voitures type Mistral ‘69, TEE « Jules Verne »

SNCF, 3-unit set of air-conditioned type Mistral ‘69 coaches, TEE “Jules Verne”



Fotomontage / Fotomontaje / Fotomontaggio / Photomontage

HN4499

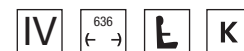

NEW



SNCF, 4-tlg. Set klimatisierter Reisezugwagen der Bauart „Mistral ‘69“, TEE „Jules Verne“

SNCF, set de 4 coches climatizados tipo Mistral ‘69, TEE “Jules Verne”

SNCF, set di 4 carrozze tipo “Mistral 69” TEE “Jules Verne”

SNCF, coffret de 4 voitures type Mistral ‘69, TEE « Jules Verne »

SNCF, 4-unit set of air-conditioned type Mistral ‘69 coaches, TEE “Jules Verne”



Fotomontage / Fotomontaje / Fotomontaggio / Photomontage



HN2651

HN4498

HN4498

HN4498



HN4499

HN4499

HN4499

HN4499



© B. Ruetsch

Les voitures « Mistral '69 »

Les voitures Mistral incarnent une véritable icône du transport ferroviaire de luxe en France durant la seconde moitié du XX^e siècle. Introduites dans les années 1960, elles ont été conçues pour offrir un confort inégalé et une expérience de voyage haut de gamme. Employées principalement sur les prestigieux Trains de Luxe et les services TEE (Trans-Europ-Express), ces voitures se distinguaient par leur élégance et leurs avancées techniques. Parmi leurs caractéristiques, on retrouve des sièges inclinables, des espaces généreux pour les jambes et un service à bord réputé pour sa qualité, incluant une restauration de haut niveau, servie à la place ou dans la voiture-restaurant.

Les voitures « **Mistral '69** », en particulier, représentaient une évolution majeure de la série, alliant des améliorations esthétiques et fonctionnelles qui en faisaient le fleuron des chemins de fer français. Ces trains opéraient sur des lignes emblématiques comme le « Mistral », reliant Paris à Marseille et Nice, ainsi que sur d'autres itinéraires internationaux prestigieux.

Un exemple notable de cette réaffectation fut l'utilisation des voitures **Mistral 69 sur le Jules Verne**, un train reliant Paris à Nantes. Ce service, inauguré le 28 septembre 1980, était composé de voitures Mistral 69 issues des parcs du Nord et du Sud-Est.

Ce réemploi témoignait de la volonté des chemins de fer français de maintenir des standards de qualité élevés sur des itinéraires non desservis par le TGV.

Cependant, malgré leur succès, l'arrivée du TGV (Train à Grande Vitesse) au début des années 1980 a marqué leur déclin. La rapidité et l'efficacité des TGV ont progressivement éclipsé le charme traditionnel de ces trains, conduisant à leur retrait ou à leur réaffectation sur des services moins prestigieux.

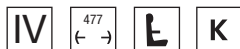
HN4500**NEW**

SNCF, 3-tlg. Set TEE-Wagen „Mistral“, Nizza - Paris, bestehend aus 1 x Vru + 1 x A8tu + 1 x AD4tux, silberne Farbgebung

SNCF, set de 3 coches climatizados TEE “Mistral”, Niza - Paris, compuesto por 1 x Vru + 1 x A8tu + 1 x AD4tux

SNCF, set di 3 carrozze TEE “Mistral”, Nizza - Parigi, composto da 1 x Vru + 1 x A8tu + 1 x AD4tux, livrea argento

SNCF, set de 3 voitures TEE «Mistral», Nice - Paris, composé de 1 x Vru + 1 x A8tu + 1 x AD4tux, livrée argente

SNCF, 3-unit set of TEE coaches “Mistral”, Nice - Paris, consisting of 1 x Vru + 1 x A8tu + 1 x AD4tux, silver livery

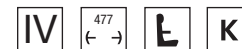

Fotomontage / Fotomontaje / Fotomontaggio / Photomontage

HN4501**NEW**

SNCF, 3-tlg. Set TEE-Wagen „Mistral“, Nizza - Paris, bestehend aus 1 x Arux + 1 x A8u + 1 x AD4tux, silberne Farbgebung

SNCF, set de 3 coches climatizados TEE “Mistral”, Niza - Paris, compuesto por 1 x Arux + 1 x A8u + 1 x AD4tux

SNCF, set di 3 carrozze TEE “Mistral”, Nizza - Parigi, composto da 1 x Arux + 1 x A8u + 1 x AD4tux, livrea argento

SNCF, set de 3 voitures TEE «Mistral», Nice - Paris, composé de 1 x Arux + 1 x A8u + 1 x AD4tux, livrée argente

SNCF, 3-unit set of TEE coaches “Mistral”, Nice - Paris, consisting of 1 x Arux + 1 x A8u + 1 x AD4tux, silver livery



Fotomontage / Fotomontaje / Fotomontaggio / Photomontage

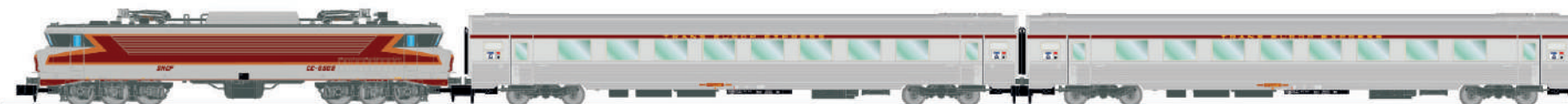

HN2650

HN4500

HN4503

HN4502

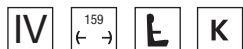

SNCF, TEE-Reisezugwagen A8u „Mistral“, Nizza – Paris, in silberner Farbgebung

SNCF, coche TEE A8u “Mistral”, Niza - París, en decoración Inox

SNCF, carrozza TEE A8u “Mistral”, Nizza - Parigi, livrea Inox

SNCF, voiture TEE A8u « Mistral », Nice - Paris, livrée Inox

SNCF, coach TEE A8u “Mistral”, Nice – Paris, silver livery

NEW



Fotomontage / Fotomontaje / Fotomontaggio / Photomontage

HN4503

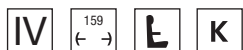

SNCF, TEE-Reisezugwagen A8tu „Mistral“, Nizza – Paris, in silberner Farbgebung

SNCF, coche TEE A8tu “Mistral”, Niza - París, en decoración Inox

SNCF, carrozza TEE A8tu “Mistral”, Nizza - Parigi, livrea Inox

SNCF, voiture TEE A8tu « Mistral », Nice - Paris, livrée Inox

SNCF, coach TEE A8tu “Mistral”, Nice – Paris, silver livery

NEW



Fotomontage / Fotomontaje / Fotomontaggio / Photomontage



HN4500

HN4502

HN4500



El Sud-Express, también conocido como Sud-Expreso, es uno de los trenes históricos más emblemáticos de Europa. Inaugurado a finales del siglo XIX, conectaba París con Lisboa, atravesando España y ofreciendo una conexión ferroviaria directa entre Francia y Portugal. Durante décadas, el Sud-Express fue sinónimo de lujo, velocidad y modernidad, convirtiéndose en un referente de los grandes trenes internacionales de la época.



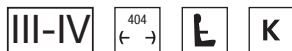

La ruta original del Sud-Express atravesaba ciudades clave como Irún, Valladolid, Salamanca y Medina del Campo antes de cruzar la frontera hacia Portugal, donde continuaba hasta Lisboa. Este recorrido no solo era funcional para viajeros de negocios o diplomáticos, sino que también atraía a turistas interesados en descubrir la Península Ibérica. Con el paso del tiempo, y especialmente con la llegada de trenes más modernos y rápidos, el Sud-Express perdió parte de su esplendor original.

Con el paso del tiempo, y especialmente con la llegada de trenes más modernos y rápidos, el Sud-Express perdió parte de su esplendor original. Sin embargo, sigue siendo un símbolo de una época dorada del ferrocarril europeo, evocando el espíritu de los viajes elegantes y la conexión cultural entre países. Hoy en día, aunque su carácter ha cambiado, el Sud-Express continúa operando en versiones más modernas, manteniendo viva la memoria de este icónico tren que marcó la historia del transporte ferroviario internacional.

HN4486



NEW

-  CIWL, 3-tlg. Zugset „Sud-Express“, Set 1/2, bestehend aus 1 x DD3 + 1 x AA 5000 in Grün mit Faltenbälgen + 1 x WL
-  CIWL, set de 3 unidades “Sud-Expreso”, set 1/2, compuesto por 1 x DD3 + 1 x AA 5000 en verde con fuelles + 1 x WL
-  CIWL, set di 3 unità “Sud Express”, set 1/2, composto da 1 x DD3 + 1 x AA 5000 livrea verde con mantici + 1 x WL
-  CIWL, coffret de 3 voitures « Sud-Express », coffret 1/2, composé de 1 x DD3 + 1 x AA 5000 en vert avec soufflets + 1 x WL
- CIWL, 3-unit set of “Sud Express”, set 1/2, consisting of 1 x DD3 + 1 x AA 5000 in green with bellows + 1 x WL





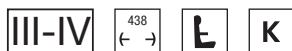

Fotomontage / Fotomontaje / Fotomontaggio / Photomontage

HN4487



NEW

-  CIWL, 3-tlg. Zugset „Sud-express“, Set 2/2, bestehend aus 1 x VPC Étoile du Nord + 2 x WL
-  CIWL, set de 3 unidades “Sud-expreso”, set 2/2, compuesto por 1 x VPC Étoile du Nord + 2 x WL
-  CIWL, set di 3 unità “Sud Express”, set 2/2, composto da 1 x VPC Étoile du Nord + 2 x WL
-  CIWL, coffret de 3 voitures « Sud-express », coffret 2/2, composé de 1 x VPC Étoile du Nord + 2 x WL
- CIWL, 3-unit set of “Sud Express”, set 2/2, consisting of 1 x VPC Étoile du Nord + 2 x WL



Fotomontage / Fotomontaje / Fotomontaggio / Photomontage

HN4458

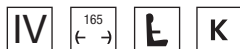

RENFE, „Guardería“-Wagen Bz5x-10500, in „Estrella“-Farbgebung

RENFE, coche Bz5x-10500 “Guardería”, decoración Estrella

RENFE, carrozza Bz5x-10500 “Guardería”, livrea Estrella

RENFE, voiture Bz5x-10500 « Guardería », livrée Estrella

RENFE, Bz5x-10500 coach “Guardería”, Estrella livery

NEW



HN4459

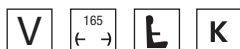

RENFE, „Superreclinable“-Wagen A8lv-10500, „Largo Recorrido“-Farbgebung

RENFE, coche A8lv-10500 “Superreclinable”, decoración “Largo Recorrido”

RENFE, carrozza A8lv-10500 “Superreclinable”, livrea “Largo Recorrido”

RENFE, voiture A8lv-10500 « Superreclinable », livrée « Largo Recorrido »

RENFE, A8lv-10500 coach “Superreclinable”, “Largo Recorrido” livery

NEW



HN4492

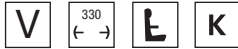

NEW



FS, 2-tlg. Set UIC-Z1-Wagen, bestehend aus 1.-Klasse-Wagen in grau/gelber Farbgebung + 2.-Klasse-Wagen in „Bandiera“ Farbgebung

FS, set de 2 coches UIC-Z1, compuesto por 1ª clase en decoración gris/amarillo + 2ª clase en decoración “Bandiera”

FS, set di 2 carrozze UIC-Z1, composto da 1ª classe in livrea grigio/giallo + 2ª classe in livrea “Bandiera”

FS, coffret de 2 voitures UIC-Z1, composé de 1^{ère} classe en livrée gris/jaune + 2^{ème} classe en livrée « Bandiera »

FS, 2-unit set of UIC-Z1, consisting of 1st class in grey/yellow livery + 2nd class in “Bandiera” livery



Fotomontage / Fotomontaje / Fotomontaggio / Photomontage

HN4493

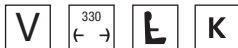

NEW



FS, 2-tlg. Set UIC-Z1-Wagen, bestehend aus 2.-Klasse-Wagen in orangefarbener Eurofima C1-Farbgebung + 2.-Klasse-Wagen in „Bandiera“ Farbgebung

FS, set de 2 coches UIC-Z1, compuesto por 2ª clase en decoración Eurofima C1 + 2ª clase en decoración “Bandiera”

FS, set di 2 carrozze UIC-Z1, composto da 2ª classe in livrea Eurofima C1 + 2ª classe in livrea “Bandiera”

FS, coffret de 2 voitures UIC-Z1, composé de 2^{ème} classe en livrée Eurofima C1 + 2^{ème} classe en livrée « Bandiera »

FS, 2-unit set of UIC-Z1, consisting of 2nd class in Eurofima C1 livery + 2nd class in “Bandiera” livery



Fotomontage / Fotomontaje / Fotomontaggio / Photomontage

HN4470



DR, 2-tlg. Doppelstockwagen der Bauart DB7 in flaschengrün-grauer Farbgebung „DEUTSCHE REICHSBAHN“

DR, set de 2 coches de doble piso, DB7, decoración verde botella/gris “DEUTSCHE REICHSBAHN”

DR, set di 2 carrozze a due piani, tipo DB7, livrea verde bottiglia/grigio “DEUTSCHE REICHSBAHN”

DR, coffret de 2 voitures à deux niveaux, type DB7, livrée vert bouteille/grise « DEUTSCHE REICHSBAHN »

DR, 2-unit set of double-decker coaches “DEUTSCHE REICHSBAHN”, type DB7, in bottle green/grey livery

NEW



Fotomontage / Fotomontaje / Fotomontaggio / Photomontage

HN4472



DR, 4-tlg. Doppelstockwagen der Bauart DBv mit Führerstand, gerade Front, blattgrün-braune Farbgebung „DR“

DR, set de 4 coches de doble piso, DBv con cabina de maquinista y frontal plano, decoración verde hoja/marrón “DR”

DR, set di 4 carrozze a due piani, tipo DBv con cabina di guida, frontale piatto, livrea “DR” verde foglia/marrone

DR, coffret de 4 voitures à deux niveaux, type DBv avec cabine de conduite, face plate, livrée vert feuille/marron, « DR »

DR, 4-unit set of double-decker coaches, type DBv with drivers cabin, straight front, leaf green/brown livery “DR”

NEW



Doppelstockzüge

Nach dem Zweiten Weltkrieg stand die deutsche Reichsbahn durch den beginnenden Wiederaufbau der Industrie vor der Herausforderung, große Verkehrsströme in den Ballungszentren schnell bewältigen zu müssen. Daher wurden ab 1952 neue und für die damalige Zeit moderne Doppelstockzüge beschafft. Bis 1974 sind 152 vierteilige Züge aus verschiedenen Baulosen – sowohl mit als auch ohne Steuerabteil – in Dienst gestellt worden.

Des Weiteren beschaffte die DR im Jahre 1955 zwölf zweiteilige Garnituren.

Die neuen Arnold-Modelle in Spur N

Die neuen Arnold-Modelle geben die Ausführungen als zweiteilige und als vierteilige Einheit wieder, je nach Version mit bzw. ohne Steuerabteil. Ab Werk besitzen alle Modelle eine eingebaute, rote Schlussbeleuchtung, die mit der Fahrtrichtung wechselt. Bei den Einheiten mit Steuerabteil ist selbstverständlich auch das Spitzenlicht beleuchtet.

Für den Einsatz im Digitalbetrieb sind hierfür 18-polige Digitalchnittstellen nach NEM 662 vorhanden. Sie sind nach Abnehmen des Gehäuses zugänglich.

Für das vorbildgerechte Fahren Puffer an Puffer sind die Doppelstockeinheiten auch mit Kurzkupplungskulissen und Kurzkupplungsköpfen an beiden Endwagen ausgerüstet.

Eingesetzt waren die Züge vorrangig im Berufs- und Vorortverkehr der Ballungsgebiete, später dann im S-Bahn-Verkehr in Rostock, Dresden, Magdeburg und Halle.

Einige der zweiteiligen Einheiten lösten auf der Strecke Dresden-Heidenau-Altenberg die bekannten Altenberger Mitteleinstiegswagen ab.

Ebenso konnten mit ihnen die Zugförderungsaufgaben auf den Steilstrecken im Thüringer Wald (Themar-Schleusingen-Ilmenau bzw. Schleusingen-Suhl) erfüllt werden.

Auch die Übergänge zwischen den Wagen sind kurzgekuppelt. Um die Wagenbreite vorbildgerecht ausführen zu können und die Arnold-Modelle gleichzeitig auch in engen Radien einsetzbar zu machen, sind die Trittstufen unter den seitlichen Einstiegstüren seitenschiebbar. Die Drehgestelle drücken die Stufen beim Durchfahren enger Kurven nach außen, in der Geraden federn sie in ihre Ausgangsposition zurück.



© Deutsche Fotothek

Fotomontage / Fotomontaje / Fotomontaggio / Photomontage



HN4481

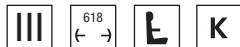

NEW



DR, 4-tlg. Set „Tourex“, Nr. 2/2, bestehend aus 1 x WR + 1 x SD + 2 x WLAB, blaue Farbgebung

DR, set de 4 coches "Tourex", set 2/2, compuesto por 1 x WR + 1 x SD + 2 x WLAB, decoración azul

DR, set 3 carrozze "Tourex", n. 2/2, composto da 1 x WR + 1 x SD + 2 x WLAB, livrea blu

DR, coffret de 4 voitures « Tourex », n° 2/2, composé de 1 x WR + 1 x SD + 2 x WLAB, livrée bleue

DR, 4-unit set of "Tourex", no. 2/2, consisting of 1 x WR + 1 x SD + 2 x WLAB, blue livery

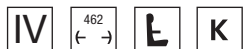

Fotomontage / Fotomontaje / Fotomontaggio / Photomontage

HN4482**NEW**

**DR, 3-tlg. Set OSShD-Wagen Typ B, Nr. 2/2,
bestehend aus 1 x A + 1 x AB + 1 x Bc, grün/beige Farbgebung**

DR, set de 3 coches tipo B "OSShD", set 2/2,
compuesto por 1 x A + 1 x AB + 1 x Bc, decoración verde/beige

DR, set 3 carrozze tipo B "OSShD", n. 2/2,
composto da 1 x A + 1 x AB + 1 x Bc, livrea verde/beige

DR, coffret de 3 voitures type B « OSShD », n° 2/2,
composé de 1 x A + 1 x AB + 1 x Bc, livrée verte/beige

DR, 3-unit set of "OSShD" coaches type B, no. 2/2,
consisting of 1 x A + 1 x AB + 1 x Bc, green/beige livery

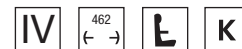

Fotomontage / Fotomontaje / Fotomontaggio / Photomontage

HN4483**NEW**

**DR, 3-tlg. Set OSShD-Wagen Typ B, Nr. 2/2,
bestehend aus 1 x WR + 2 x B, grün/beige Farbgebung**

DR, set de 3 coches tipo B "OSShD", set 2/2,
compuesto por 1 x WR + 2 x B, decoración verde/beige

DR, set 3 carrozze tipo B "OSShD", n. 2/2,
composto da 1 x WR + 2 x B, livrea verde/beige

DR, coffret de 3 voitures type B « OSShD », n° 2/2,
composé de 1 x WR + 2 x B, livrée verte/beige

DR, 3-unit set of "OSShD" coaches type B, no. 2/2,
consisting of 1 x WR + 2 x B, green/beige livery



Fotomontage / Fotomontaje / Fotomontaggio / Photomontage

HN4478



RENFE, 2-tlg. Zugpackung aus Wagen des Typs 5000, bestehend aus 2 x BB4 2. Kl., olivgrüne Lackierung

RENFE, set de 2 coches tipo 5000, compuesto de dos coches BB4 de 2ª clase, decoración verde oliva

RENFE, set di 2 carrozze tipo 5000, composto da due BB4 di 2ª classe, livrea verde oliva

RENFE, coffret 2 voitures type 5000, composé de 2 x BB4 2^{ème} classe, livrée vert olive

RENFE, 2-unit pack type 5000 coaches, contains 2 x BB4 2nd class, olive green livery

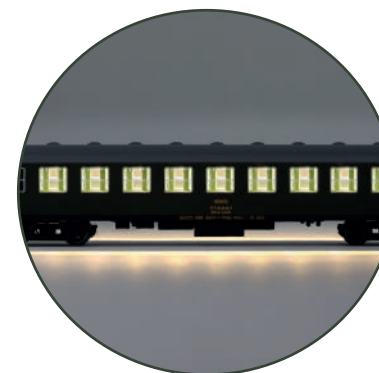

Coches equipados con iluminación interior

Con iluminación interior de fábrica

En Arnold hemos reproducido esta amplia serie de vehículos, en las variedades anteriormente mencionadas en su estado de época IV, en decoración verde oliva con matrículas UIC, distribuidos en dos sets que cuentan con iluminación interior de fábrica y que forman una composición perfecta, tal y como se podía ver durante los años 70 y 80 en trenes de viajeros de todo tipo, como los famosos “omnibuses”.



HN2562-HN2562S

HN4477

HN4477



HN4478

HN4478

HN4477

HN4479



RENFE, 2-tlg. Zugpackung aus Wagen des Typs 5000, bestehend aus 1 x AAR-Barwagen + 1 x BB1 2. Kl., beide in „Estrella“-Farbgebung

RENFE, set de 2 coches tipo 5000, compuesto de un coche AAR cafetería y un BB1 de 2ª clase, decoración “Estrella”

RENFE, set di 2 carrozze tipo 5000, composto da 1 carrozza bar AAR + 1 BB1 di 2ª classe, livrea “Estrella”

RENFE, coffret de 2 voitures type 5000, composé de 1 x AAR voiture-bar + 1 x BB1 2^{ème} classe, livrée « Estrella »

RENFE, 2-unit pack type 5000 coaches, contains 1 x AAR bar coach + 1 x BB1 2nd class, both in “Estrella” livery



2

Testeros detallados y cinemática de enganche corto

Los nuevos “Estrellas” de Arnold

En Arnold hemos fabricado el set HN4479, compuesto por dos estos coches. El primero reproduce el mixto-cafetería AAR-5098, con todas sus particularidades, como los logotipos sin el aro exterior y los marcos

de las ventanas pintados en marrón como el resto de la carrocería. El segundo es el coche BB1-5245, con su tipografía moderna y logos renovados. Ambos cuentan con luz interior y son ideales para

complementar cualquier composición de viajeros de su época, aportando la elegancia característica de esta vistosa livrea.



HN2593-HN2593S

HN4295

HN4295

HN4295



HN4479

HN4295

HN4479

1

Marcos de ventanas en color marrón



HN4480



ALSA, 3-tlg. Zugpackung aus Wagen des Typs 6000, bestehend aus 1 x BB1, 1 x BB und 1 x DV in olivgrüner Farbgebung

ALSA, set de 3 coches, compuesto de un coche BB1 de 2ª clase, un BB de 2ª clase y un DV furgón, decoración verde oliva

ALSA, set di 3 carrozze tipo 6000, composto da 1 x BB1, 1 x BB + 1 x DV, livrea verde oliva

ALSA, coffret de 3 voitures type 6000, composé de 1 x BB1, 1 x BB + 1 x DV, livrée vert olive

ALSA, 3-unit pack type 6000 coaches, contains 1 x BB1, 1 x BB + 1 x DV, in olive green livery



2

Decoración reproducida fielmente con matrícula Alsa



Modelo

Arnold ha fabricado una réplica completa del Tren de Felipe II en tres referencias: la locomotora 2150 en verde-amarillo (referencia HN2634/S), el set HN4455 con dos coches de 7 departamentos, y el set HN4480 que incluye el furgón calderín y dos coches adicionales con luz interior, incluido el particular BB-5000 de 8 departamentos.



1

Furgón de acompañamiento tipo DV



1

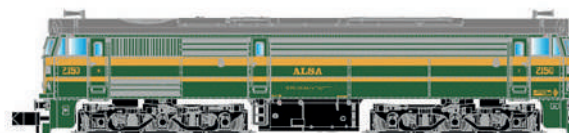

HN2634-HN2634S

HN4480

HN4480

TREN DE FELIPE II



2



HN4480

HN4455

HN4455

HN4505

III-IV

165
← →

K

NEW



RENFE, Postwagen DGCT-7, olivgrüne Farbgebung mit großen Buchstaben

RENFE, furgón postal DGCT-7 "Furgón Postal nº7", decoración verde oliva con letras grandes

RENFE, carrozza postale DGCT-7 "Furgón Postal nº7", livrea verde oliva con grandi lettere

RENFE, fourgon postal DGCT-7 « Furgón Postal nº7 », livrée verte olive avec grandes lettres

RENFE, DGCT-7 postal van "Furgón Postal nº7", olive green livery with large lettering



Los Furgones Postales Largos DGCT-1 a 16

Hasta la década de los 60, la Dirección General de Correos tenía escasez de furgones de gran capacidad para la correspondencia y paquetería de gran volumen. Por este motivo, Correos encargó la construcción de 16 furgones diáfanos de gran capacidad, basados en el modelo UIC-X, que se entregaron entre 1965 y 1968.

Muy pronto fue posible verlos por casi toda la geografía española. En apenas unos años la demanda de ciertos trayectos fue tan grande que se hizo necesaria la creación de trenes puros, los Trenes Postales. Estos se encargarían de las relaciones principales, encaminando luego los furgones mediante los principales trenes expresos, así como omnibuses y otros trenes secundarios de viajeros.

Se decoraron inicialmente con el característico verde oliva a juego con el material de viajeros de la época, siendo destacables sus grandes inscripciones centrales en amarillo para identificarlos. Posteriormente, con el cambio de la imagen corporativa de Correos, se les aplicó la vistosa decoración amarilla con bandas rojas al igual que al resto de material de la DGCT.

Fotomontage / Fotomontaje / Fotomontaggio / Photomontage



HN4506

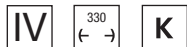

NEW



RENFE, 2-tlg. Set Postwagen, bestehend aus 1 x DGCT-2 + 1 x DGCT-10, gelbe Farbgebung

RENFE, set de 2 furgones postales, compuesto por 1 x DGCT-2 + 1 x DGCT-10, decoración amarillo

RENFE, set 2 carrozze postali, composto da 1 x DGCT-2 + 1 x DGCT-10, livrea gialla

RENFE, coffret de 2 fourgons postaux, composé de 1 x DGCT-2 + 1 x DGCT-10, livrée jaune

RENFE, 2-unit set of postal van, consisting of 1 x DGCT-2 + 1 x DGCT-10, in yellow livery



Fotomontage / Fotomontaje / Fotomontaggio / Photomontage



HN6700

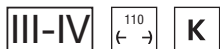

FS, 2-tlg. Set 2-achs. Kesselwagen „Agip“ in silberner Farbgebung

FS, set con 2 vagoni cisterna de dos ejes “Agip” en decoración plata

FS, set di 2 carri cisterna a 2 assi “Agip”, livrea argento

FS, coffret de 2 wagons-citernes à 2 essieux « Agip » en livrée argentée

FS, 2-unit set of 2-axle tank wagons “Agip”, silver livery

NEW



Fotomontage / Fotomontaje / Fotomontaggio / Photomontage

HN6701

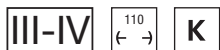

FS, 2-tlg. Set 2-achs. Kesselwagen „Shell“ in silberner Farbgebung

FS, set con 2 vagoni cisterna de dos ejes “Shell” en decoración plata

FS, set di 2 carri cisterna a 2 assi “Shell”, livrea argento

FS, coffret de 2 wagons-citernes à 2 essieux « Shell » en livrée argentée

FS, 2-unit set of 2-axle tank wagons “Shell”, silver livery

NEW



Fotomontage / Fotomontaje / Fotomontaggio / Photomontage

HN6702

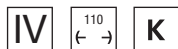

SNCF, 2-tlg. Set 2-achs. Tankwagen „BYRRH“ Farbgebung

SNCF, set de 2 vagones cisterna de 2 ejes, decoración “BYRRH”

SNCF, set di 2 carri cisterna a 2 assi, livrea “BYRRH”

SNCF, coffret de 2 wagons-citernes à 2 essieux, livrée « BYRRH »

SNCF, 2-unit set of 2-axle tank wagons, “BYRRH” livery



Beide Wagen mit vorbildgeecht unterschiedlicher Bedruckung auf beiden Seiten.

Fotomontage / Fotomontaje / Fotomontaggio / Photomontage

NEW

HN6633

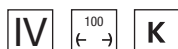

SNCF, 4-achs. Tankwagen „Elf“ in schwarzer Farbgebung

SNCF, vagón cisterna de 4 ejes, decoración “Elf”

SNCF, carro cisterna a 4 assi, livrea “Elf”

SNCF, wagon-citerne à 4 essieux, livrée « Elf »

SNCF, 4-axle tank wagon, “Elf” livery

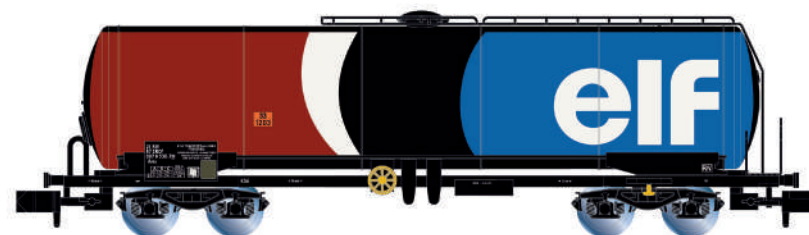

NEW

HN6634

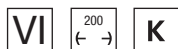

SNCF, 2-tlg. Set Chlor-Tankwagen „VTG + Ermewa“, in beige/orange/roter Farbgebung

SNCF, set de 2 vagones cisterna para transporte de cloro “VTG + Ermewa”, decoración beige/naranja/roja

SNCF, set di 2 carri cisterna per trasporto cloro “VTG + Ermewa”, livrea beige/arancio/rossa

SNCF, coffret de 2 wagons-citernes pour le transport du chlore « VTG + Ermewa », livrée beige/orange/rouge

SNCF, 2-unit set of chlorine tank wagons “VTG + Ermewa”, in beige/orange/red livery



NEW

HN6635

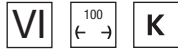

NEW



D-ERMD, 4-achs. Kesselwagen „Enviloc“, blaue Farbgebung

D-ERMD, vagón cisterna de 4 ejes “Enviloc”, decoración azul

D-ERMD, carro cisterna a 4 assi “Enviloc”, livrea blu

D-ERMD, wagon-citerne à 4 essieux « Enviloc », livrée bleue

D-ERMD, 4-axle tank wagon “Enviloc”, blu livery



HN6687

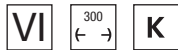

NEW



D-BAS, 3-tlg. Set Kesselwagen „MAD“, Farbgebung mit neuen Tiermotiven

D-BAS, set de 3 vagones cisterna “MAD”, decoración con nuevos animales

D-BAS, set di 3 carri cisterna “MAD”, livrea con nuovi animali

D-BAS, coffret de 3 wagons-citernes « MAD », avec de nouveaux motifs d'animaux

D-BAS, 3-unit set of tank wagons “MAD”, livery with new animals



HN6703

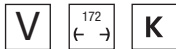

RENFE, 2-tlg. Set JPD-Wagen „TEM“, grüne Farbgebung

RENFE, set de 2 vagones JPD “TEM”, decoración verde

RENFE, set di 2 carri JPD “TEM”, livrea verde

RENFE, coffret de 2 wagons JPD « TEM », livrée verte

RENFE, 2-unit set of JPD wagons “TEM”, green livery



Fotomontage / Fotomontaje / Fotomontaggio / Photomontage

NEW

HN6704

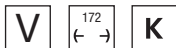

RENFE, 2-tlg. Set JPD-Wagen „San Miguel“, beige/grün

RENFE, set de 2 vagones JPD “San Miguel”, beige/verde

RENFE, set di 2 carri JPD “San Miguel”, beige/verde

RENFE, coffret de 2 wagons JPD « San Miguel », beige/vert

RENFE, 2-unit set of JPD wagons “San Miguel”, beige/green



Fotomontage / Fotomontaje / Fotomontaggio / Photomontage

HN6707

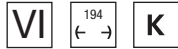

NEW



GATX, 2-tlg. Set 4-achs. Getreidesilowagen „RAIL CARGO GROUP“, neongrüne Farbgebung

GATX, set de 2 vagones tolva redondeados de 4 ejes “RAIL CARGO GROUP”, decoración verde neón

GATX, set di 2 carri silo a pareti curve a 4 assi “RAIL CARGO GROUP”, livrea verde neon

GATX, coffret de 2 wagons silos à parois bombées à 4 essieux « RAIL CARGO GROUP », livrée vert néon

GATX, 2-unit set of 4-axle round-sided silo wagons “RAIL CARGO GROUP”, neon-green livery



HN6708

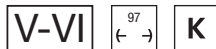

NEW



4-achs. Getreidesilowagen „Tucher“

Vagón tolva para cereales de 4 ejes “Tucher”

Carro tramoggia per trasporto cereali a 4 assi “Tucher”

Wagon-trémie pour céréales à 4 essieux « Tucher »

4-axle cereal hopper wagon “Tucher”

Getreide gehört auf die Schiene!

Für den Transport des Getreides zur Mälzerei führt der Weg oft über die Schiene, speziell bei den größeren Brauereien. Unser neues Arnold-Modell ist ein solcher Getreidesilowagen, verziert mit der Werbung der bekanntesten Nürnberger Brauerei Tucher.



HN6709

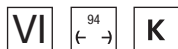

FS, Getreidesilowagen „Monfer“, Typ Uagpps, mit neuen Beschriftungen, graue Farbgebung mit roten Streifen

FS, vagón tolva “Monfer”, tipo Uagpps, con nuevas inscripciones, decoración gris con rayas rojas

FS, carro tramoggia “Monfer”, tipo Uagpps, con nuove iscrizioni, livrea grigia con strisce rosse

FS, wagon-trémie « Monfer », type Uagpps, avec nouvelles inscriptions, livrée grise avec bandes rouges

FS, hopper wagon “Monfer”, type Uagpps, with new inscriptions, grey livery with red stripes

NEW



HN6710

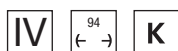

FS, Getreidesilowagen „Pagnan“, Typ Uas

FS, vagón tolva “Pagnan”, tipo Uas

FS, carro tramoggia “Pagnan”, tipo Uas

FS, wagon-trémie « Pagnan », type Uas

FS, hopper wagon “Pagnan”, type Uas

NEW

Pagnan Commerciale Srl è una divisione del fornitore di generi alimentari Pagnan che si concentra su attività commerciali come l'importazione e il commercio di cereali. Nel 2005 è stata acquisita da Cargill, una società internazionale attiva in vari settori e nota tra gli esperti di ferromodellismo per la loro flotta di carri tramoggia per cereali. Il nuovo modello Arnold rappresenta un carro tramoggia per cereali che mostra ancora il logo Pagnan degli anni '70.



HN6705

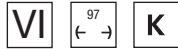

F-MISA, 4-achs. Getreidesilowagen „Millet“, mit runden Wänden, Farbgebung mit „Telefoot“-Graffiti

F-MISA, vagón tolva para cereales de 4 ejes "Millet", con paredes redondeadas, decoración con graffiti "Telefoot"

F-MISA, carro tramoggia per trasporto di cereali a 4 assi "Millet", con pareti arrotondate, livrea con graffiti "Telefoot"

F-MISA, wagon-trémie pour céréales à 4 essieux « Millet », avec parois arrondies, livrée avec graffitis « Telefoot »

F-MISA, 4-axle cereal hopper wagon "Millet", with rounded walls, livery with "Telefoot" graffiti

NEW



HN6706

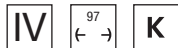

SNCF, 4-achs. Güterwagen zum Transport von Zucker, „Cantalou“

SNCF, vagón tolva para el transporte de azúcar de 4 ejes "Cantalou"

SNCF, carro tramoggia per zucchero a 4 assi "Cantalou"

SNCF, wagon sucrier à 4 essieux « Cantalou »

SNCF, 4-axle sugar hopper wagon "Cantalou"

NEW



HN6670

V-VI ²¹²
← →

K



RENFE Mercancías, 2-tlg. Set vierachsiger Selbstentladewagen der Bauart Faos, grüne Farbgebung

RENFE Mercancías, set de dos vagones tolva tipo Faos, decoración verde

RENFE Mercancías, set di 2 carri tramoggia Faos a 4 assi, livrea verde

RENFE Mercancías, coffret de 2 unités wagons trémies à 4 essieux Faos, livrée verte

RENFE Mercancías, 2-unit pack 4-axle hopper wagons Faos, green livery



HN6671

IV-V ²¹²
← →

K



RENFE, 2-tlg. Set vierachsiger Selbstentladewagen der Bauart Faos „SALTRA / CARFE“, braune Farbgebung, beladen mit Kohle

RENFE, set de dos vagones tolva tipo Faos, decoración marrón “SALTRA / CARFE”, cargado con carbón

RENFE, set di 2 carri tramoggia per carbone Faos a 4 assi “SALTRA / CARFE”, livrea marrone, con carico di carbone

RENFE, coffret de 2 wagons trémies à charbon à 4 essieux Faos « SALTRA / CARFE », livrée marron, chargé de charbon

RENFE, 2-unit pack 4-axle coal hopper wagons Faos “SALTRA / CARFE”, brown livery, loaded with coal



HN6678

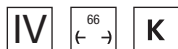

SNCF, 2-achs. gedeckter Güterwagen „JOUEF Trains“, Typ G4, mit Permaplex-Wänden

SNCF, vagón cerrado de 2 ejes “JOUEF Trains”, tipo G4, con paredes planas

SNCF, carro chiuso a 2 assi “JOUEF Trains”, tipo G4, con pareti Permaplex

SNCF, wagon couvert à 2 essieux « JOUEF Trains », type G4, avec parois Permaplex

SNCF, 2-axle closed wagon “JOUEF Trains”, type G4, with Permaplex walls



NEW

Fotomontage / Fotomontaje / Fotomontaggio / Photomontage

HN6679

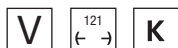

Colas Rail, 2-tlg. Set bestehend aus einem 2-achs. Kesselwagen und einem gedecktem Güterwagen der Bauart G4

Colas Rail, set de un vagón cisterna de 2 ejes y un vagón cerrado de 2 ejes tipo G4

Colas Rail, set di 1 carro cisterna a 2 assi + carro chiuso a 2 assi tipo G4

Colas Rail, coffret de 2 wagons-citernes à 2 essieux + wagon couvert à 2 essieux type G4

Colas Rail, 2-unit set of 2-axle tank wagon + 2-axle G4 wagon



NEW

Fotomontage / Fotomontaje / Fotomontaggio / Photomontage

HN6683

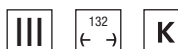

SBB, 2-tlg. Set 2-achs. gedeckter Güterwagen der Bauart K4 „APROZ“

SBB, set de 2 wagones cerrados de 2 ejes K4 “APROZ”, tipo Gs

SBB, set di 2 carri chiusi a 2 assi K4 “APROZ”, tipo Gs

SBB, coffret de 2 wagons couvert à 2 essieux K4 « APROZ », type Gs

SBB, 2-unit set of 2-axle closed wagon “APROZ”, type K4



NEW

Abb. zeigt Spur-H0 Modell / L'immagine mostra il prodotto in scala H0 / Picture shows H0 scale model

HN6711

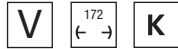

NEW



RENFE, 2-tlg. Set 2-Achs Schiebeplanenwagen, Typ Lis, mit modernem Transfesa-Logo

RENFE, set de 2 vagones entoldados de 2 ejes, tipo Lis, con logotipo moderno de Transfesa

RENFE, set di 2 carri telonati a 2 assi, tipo Lis, con logo Transfesa moderno

RENFE, coffret de 2 wagons bâché à 2 essieux, type Lis, avec logo Transfesa moderne

RENFE, 2-unit set of 2-axle tarpaulin wagon, Lis type, with Transfesa modern logo



HN6712

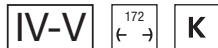

NEW



SNCF, 2-tlg. Set 2-Achs Schiebeplanenwagen „Citroën“, Typ Kijls K70

SNCF, set de 2 vagones entoldados de 2 ejes “Citroën”, tipo Kijls K70

SNCF, set di 2 carri telonati a 2 assi “Citroën”, tipo Kijls K70

SNCF, coffret de 2 wagons bâché à 2 essieux « Citroën », type Kijls K70

SNCF, 2-unit set of 2-axle tarpaulin wagon “Citroën”, Kijls K70 type





Photo: Antonio Rampini
ASN - Associazione Nazionale Amici Scala N

Bereits lieferbar • Encore disponibles • Ancora disponibili • Aún disponibles • Still available

Die als „bereits lieferbar“ gekennzeichneten Produkte könnten in begrenzter Menge verfügbar sein oder bereits ausverkauft sein

Les produits indiqués comme « déjà disponibles » pourraient être disponibles en quantité limitée ou déjà épuisés

I prodotti segnalati come "ancora disponibili" potrebbero essere disponibili in quantità limitata o già esauriti

Los productos marcados como «aún disponibles» pueden estar disponibles en cantidad limitada o ya agotados

Products marked as "still available" may be available in limited quantity or already sold out



HN2351

RENFE, automotor diesel 591-531 "Ferrobús", de dos coches, decoración plata con matrículas UIC, ép. IV



HN2352

RENFE, automotor diesel 591-330 "Ferrobús", de tres coches, decoración plata sin matrículas UIC, ép. III



HN2353/HN2353S

RENFE, automotor diesel 591-566 "Ferrobús", de dos coches, decoración "Estrella", ép. IV



Características de los modelos 591.300 y 591.500

- Diseño completamente nuevo, con moldes para todas las versiones
- Carrocerías e interior detallados, acordes a las sub-series reales
- Chasis en metal para una buena tracción
- Motor 5 polos, de tamaño ultrarreducido, con volantes de inercia
- Tracción a los dos ejes del coche motor
- Cinemáticas de enganche corto

- Conexión eléctrica entre coches
- Cajetín NEM para formar dobles composiciones, con barra de acoplamiento
- Luz interior y frontales independientes
- Luces de cola según dirección
- Modelos disponibles en analógico y sonido
- Proyecto de sonido específicamente desarrollado
- Conector digital de Next18 (NEM 662)
- Longitud: 172 mm (unidad de dos coches) / 256 mm (unidad de tres coches)





HN2481/HN2481S

SNCF, locomotive à vapeur 141 R 1173 "Mistral", avec des roues boxpok sur tous les essieux, grande capacité de carburant du tender, livrée noir, ép. III



HN2483

SNCF, locomotive à vapeur 141 R 1155, avec des roues boxpok sur tous les essieux, grande capacité de carburant du tender, livrée noir, ép. III



HN2485

DRB, Dampflokomotive BR 42 in Tarnlackierung, Ep. II



HN2486/HN2486S

DB, Dampflokomotive 42 2332 in schwarz/roter Lackierung, mit drittem Spitzenlicht, Ep. III



HN2487/HN2487S

DR, Dampflokomotive 42 1792 in schwarz/roter Lackierung, mit drittem Spitzenlicht, Ep. III



HN2490D

ÖBB, Diesellokomotive Rh 2050.05, in dunkelgrüner Lackierung, Ep. V



HN2494

DB, 3-tlg. Set elektrischer Triebzug BR 420, zwei Stromabnehmer, in grau/oranger Lackierung, Ep. IV



HN2495

DB, 3-tlg. Set elektrischer Triebzug BR 420, zwei Stromabnehmer, in grau/blauer Lackierung, Ep. IV



HN2496/HN2496S

DB, 3-tlg. Set elektrischer Triebzug BR 420, zwei Stromabnehmer, in „Coca-Cola“-Lackierung, Ep. IV





HN2517/HN2517S

DB AG, Elektrolokomotive 181 207-2, in blauer Lackierung, Ep. V



- Rahmen aus Metallspritzguss, Gehäuse aus hochwertigem Kunststoff
- Die Lokomotiven besitzt eine detaillierte und beleuchtete Maschinenraumeinrichtung (im Digitalbetrieb mit Flackern der Leuchtstoffröhren beim Einschalten)
- Beidseitig Kurzkupplungskinematiken mit Kupplungsaufnahmen nach NEM 355
- Spitzen- und Schlusslichter je nach Fahrtrichtung beleuchtet und im Digitalbetrieb schaltbar
- Viele extra angesetzt Details und feinste aus
- Alle Modellausführungen auch mit Sound erhältlich. Der Sound wurde in Zusammenarbeit mit ESU speziell von uns für dieses Modell entwickelt



HN2521/HN2521S

ÖBB, Dieseltriebwagen 5047 075-6 in grau/blau/roter Lackierung mit „Pflansch“-Logo, Ep. IV-V



- Neue Bedruckungsvarianten bzw. Betriebsnummern
- Jetzt neu: Sound-Variante mit Rechtecklautsprecher (15 x 8 mm)
- Jetzt mit Innenbeleuchtung, im Digitalbetrieb schaltbar
- Spitzenlicht und Schlusslichter je nach Fahrtrichtung beleuchtet
- Kurzkupplungsmechanik mit NEM-Kupplungsaufnahmen an beiden Enden des Triebwagens



HN2522/HN2522S

ÖBB, 2-tlg. Dieseltriebwagen Reihe 5047 (motorisiert + Dummy) in rot/blau/beiger Lackierung, mit neuem „ÖBB“-Logo, Ep. IV-V
Diesel



- Kräftiger Fünfpolmotor mit Schwungmassen
- Digitalschnittstelle: NEM 662 (Next-18)
- Mindestradius (wie bei allen Arnold-Modellen): 192 mm



HN2523D

DR, Elektrolokomotive BR 211, in roter Lackierung mit breitem Zierstreifen, Ep. IV



HN2525/HN2525D

DR, Elektrolokomotive BR 251, in grüner Lackierung mit rotem Fahrwerk, Ep. IV



HN2526/HN2526D

DR, Elektrolokomotive BR 251, in roter Lackierung mit schmalen Zierstreifen, Ep. IV



HN2606/HN2606S

DB, Elektrolokomotive 181 211-4, in blau/beiger Lackierung, „Lorraine“, Ep. IV



HN2547/HN2547S

SNCF, locomotive électrique CC 14004, avec 4 phares, livrée bleue, ép. III



HN2548/HN2548S

SNCF, locomotive électrique CC 14005, avec 4 phares, livrée verte, ép. IV



- Châssis et caisse fabriqués en métal
- Bogies, châssis et caisse différentes selon sous-série
- Pantographes entièrement fabriqués en métal
- Feux blancs alternant avec le sens de la marche
- Version analogique avec interface numérique selon NEM 662 (ne convient que pour les très petits décodeurs), variante sonore avec décodeur multiprotocole intégré sur la carte principale.

HN2549/HN2549S

SNCF, locomotive électrique CC 14111, avec 4 phares, livrée bleue, ép. III



HN2552/HN2552S

FS, set di 2 automotrici diesel ALn 668 serie 3100, livrea d'origine azzurra/beige, vetri piani, ep. V



- Meccanica con telaio in metallo, motore centrale a 5 poli con trasmissione a doppio albero cardanico su entrambi gli assi di entrambi i carrelli, due ruote con anello di aderenza
- Set composti da un'automotrice motorizzata ed una folle
- Impianto elettrico con interfaccia Next18 (NEM 662) per decoder DCC e DCC Sound, predisposizione per altoparlante "sugar cube" 11 x 15 mm
- Versioni "S" con decoder sonoro ESU Loksound Micro V5 ed altoparlante installati di serie, con suoni specifici per il modello
- Luci bianche di testa e rosse di coda con commutazione automatica in base al senso di marcia, con comando indipendente del terzo faro (in funzionamento digitale) e possibilità di esclusione selettiva delle luci delle testate, in funzionamento digitale tramite decoder e in funzionamento analogico tramite DIP switches
- Illuminazione interna di serie su tutte le unità

HN2563/HN2563S

DB, Elektrolokomotive E 03 001 in beige/roter Lackierung mit silbernem Dach, Einholmstromabnehmer, Ep. III



- Rahmen aus Metallspritzguss, Gehäuse auch hochwertigem Kunststoff
- Die Lokomotiven besitzt eine detaillierte und beleuchtete Maschinenraumeinrichtung (im Digitalbetrieb mit Flackern der Leuchtstoffröhren beim Einschalten)
- Kräftiger Fünfpolmotor mit Schwungmassen
- Alle Radsätze angetrieben
- Beidseitig Kurzkupplungskinematiken mit Kupplungsaufnahmen nach NEM 355

HN2564/HN2564S

DB, Elektrolokomotive 103 004 in beige/roter Lackierung mit dunkelbrauem Dach. Einholmstromabnehmer. Ep. IV



- Spitzen- und Schlusslichter je nach Fahrtrichtung beleuchtet und im Digitalbetrieb schaltbar
- Viele extra angesetzt Details und feinste aus Metall gefertigte Stromabnehmer
- Alle Modellausführungen auch mit Sound erhältlich Der Sound wurde in Zusammenarbeit mit ESU speziell von uns für dieses Modell entwickelt
- Digitalschnittstelle nach NEM 662 („Next 18“);
- Mindestradius: 192 mm
- Länge über Puffer: 121 bzw. 126 mm



HN2556/HN2556D

RENFE OPERADORA, locomotora eléctrica serie 252, decoración «Mercancías», ép. VI





HN2565/HN2565S

DB, Elektrolokomotive 103 140 in orientroter Lackierung, Einholmstromabnehmer, Ep. IV



- Rahmen aus Metallspritzguss, Gehäuse auch hochwertigem Kunststoff
- Die Lokomotiven besitzt eine detaillierte und beleuchtete Maschinenraumeinrichtung (im Digitalbetrieb mit Flackern der Leuchtstoffröhren beim Einschalten)
- Kräftiger Fünfpolmotor mit Schwungmassen
- Alle Radsätze angetrieben
- Beidseitig Kurzkupplungskinematiken mit Kupplungsaufnahmen nach NEM 355



HN2566/HN2566S



RailAdventure, Elektrolokomotive 103 222-6, mit langen Führerständen, Einholmstromabnehmer, in grauer Lackierung, Ep. VI



- Spitzen- und Schlusslichter je nach Fahrtrichtung beleuchtet und im Digitalbetrieb schaltbar
- Viele extra angesetzt Details und feinste aus Metall gefertigte Stromabnehmer
- Alle Modellausführungen auch mit Sound erhältlich Der Sound wurde in Zusammenarbeit mit ESU speziell von uns für dieses Modell entwickelt
- Digitalschnittstelle nach NEM 662 („Next 18“);
- Mindestradius: 192 mm
- Länge über Puffer: 121 bzw. 126 mm



HN2567/HN2567S



SBB, 4-tlg. Set elektrischer Triebzug RABe 503 018 "Astoro", "ECE 190 München – Zürich", Ep. VI



- Digitalschnittstelle NEM 662 (Next 18)
- Mit eingebauter Innenbeleuchtung
- Motor mit Schwungmasse
- Kurzkupplungs-Mechanik eingebaut
- Spitzen- und Schlussbeleuchtung mit der Fahrtrichtung wechselnd



HN3510



SBB, 3-tlg. Ergänzungsset zu HN2567, Ep. VI



HN2569/HN2569S

FS, set di 2 automotrici diesel ALn 668 serie 3100, livrea d'origine azzurra/beige, vetri curvi, ep. IV



HN2570/HN2570S

FS, automotrice diesel ALn 668 1207, livrea "Inox", ep. IV-V



HN2567-1

HN3510-1

HN3510-2

HN2567-2

HN2567-3

HN3510-3

HN2567-4



- La carrozzeria è in plastica stampata con cornici dei finestrini finemente incise e tampografate, tendine alle finestre e altri dettagli interni
- Il telaio è in metallo e monta un motore a cinque poli con doppio volano e trasmissione cardanica con cascata di ingranaggi su entrambi i carrelli.
- Il raggio minimo è indicato in 192 mm
- Il modello Arnold presenta un'interessante illuminazione interna di serie, insieme a luci di testa bianche e di coda rosse a controllo direzionale

HN2571/HN2571S

FS, set di 2 automotrici diesel ALn 668 serie 1000, livrea XMPR, vetri piani, ep. V



- Il terzo faro può essere acceso in maniera indipendente in modalità digitale
- Il modello è dotato inoltre di una presa Next18 (NEM 662) per un decoder DCC ed è predisposto per l'installazione di un altoparlante "sugar cube" da 11 x 15 mm
- I modelli dotati di suono (HN2571S) sono dotati di un decoder ESU Loksound Micro V5 integrato, con altoparlante e suoni specifici

HN2572/HN2572S

FS, automotrice diesel ALn 668 serie 3300, livrea rossa "Kimbo", ep. V



Scopri la locomotiva nel dettaglio con il video di Andrea Picard

HN2574/HN2574S

FS, locomotiva diesel D.445, 3a serie, 4 luci basse, livrea MDVC, ep. IV-V



Frontale specifico per unità di terza serie, con fanali bianchi e rossi separati e logo FS a televisore

- Meccanica con telaio in metallo, motore coreless centrale con trasmissione a doppio albero cardanico su entrambi gli assi di entrambi i carrelli, due ruote con anello di aderenza
- Raggio minimo di curvatura: 192 mm
- Impianto elettrico con interfaccia Next18 (NEM 662) per decoder DCC e DCC Sound, predisposizione per altoparlante "sugar cube" 11 x 15 mm
- Versioni "S" con decoder sonoro ESU Loksound Micro V5 ed altoparlante installati di serie, con suoni specifici per il modello
- Luci bianche di testa e rosse di coda con commutazione automatica in base al senso di marcia, con comando indipendente di luci rosse e terzo faro (in funzionamento digitale) e possibilità di esclusione selettiva delle luci delle testate, in funzionamento digitale tramite decoder e in funzionamento analogico tramite DIP switches
- Timone di allontanamento per aggancio corto su entrambe le testate, gancio con innesto standard secondo le norme NEM 355/356/357 per la scala N
- Fanaleria, vetri frontali, loghi FS ed accoppiatori coerentemente differenziati in base alla serie e all'epoca riprodotta

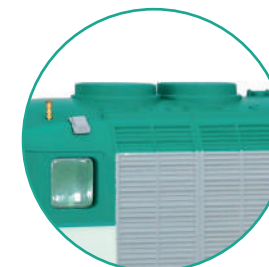

HN2575S

FS, locomotiva diesel D.445, 3a serie, 4 luci basse, livrea XMPR, ep. VI



Riproduzione delle antenne SSC sul tetto

HN2577/HN2577S

 FS, set di 4 unità, elettrotreno ad alta velocità ETR 610, "ECE Milano – Frankfurt", livrea "Frecciargento", ep. VI



- Presa NEM per decoder 662 (Next 18)
- Lunghezza fuori respingenti 690 mm
- Motore con volano

HN2587/HN2587S

SNCF, locomotive électrique CC 6541 « Maurienne », livrée verte, ép. IV





- Nouveaux moules
- Châssis fabriqués en zamak
- Caisse différente selon sous-série
- Pantographes entièrement fabriqués en métal

HN4462

RENFE, set base de 6 unidades, Talgo 200, decoración azul/blanca con franja amarilla, ép. V



HN3511

 FS, set di 3 carrozze intermedie per HN2577, livrea "Frecciargento", ep. VI



- Gancio corto con cinematismo a norma NEM
- Carrozze di testa con luci reversibili bianche e rosse

HN2588/HN2588S

SNCF, locomotive électrique CC 6512, livrée « Béton », ép. IV



- Feux blancs et rouges alternant avec le sens de la marche
- Mécanismes d'attelage court aux deux extrémités de la locomotive
- Moteur haute performance à cinq pôles avec volants d'inertie
- Interface numérique selon NEM 662 (Next-18)

HN4463

RENFE, set de 2 coches adicionales de segunda clase, decoración azul/blanca con franja amarilla, ép. V



HN2578/HN2578S

RENFE, set de 4 unidades, automotor eléctrico de alta velocidad S-114, decoración «75 aniversario RENFE», ép. VI



- Enchufe para receptor digital NEM 662 (Next 18)
- Motor con volante de inercia
- Locomotora con luces reversibles blancas y rojas

HN2592/HN2592S

RENFE, locomotora eléctrica clase 269.200, decoración «Talgo 200» con franja amarilla, ép. V



HN4464

RENFE, set de 2 coches adicionales, decoración azul/blanca con franja amarilla, compuesto de 1 coche de primera clase y 1 coche bar, ép. V



HN2593/HN2593S

RENFE, locomotora eléctrica clase 269.200, decoración «Milrayas», ép. IV



HN2594/HN2594D

RENFE, locomotora eléctrica clase 253, decoración blanca/violeta, «Transporte Sostenible», ép. VI



HN2595/HN2595D

COMSA, locomotora eléctrica clase 253, decoración azul/blanca, ép. VI



HN2596/HN2596D

DB AG, Elektrolokomotive BR 147.5 in weißer Lackierung mit rotem Streifen, Ep. VI

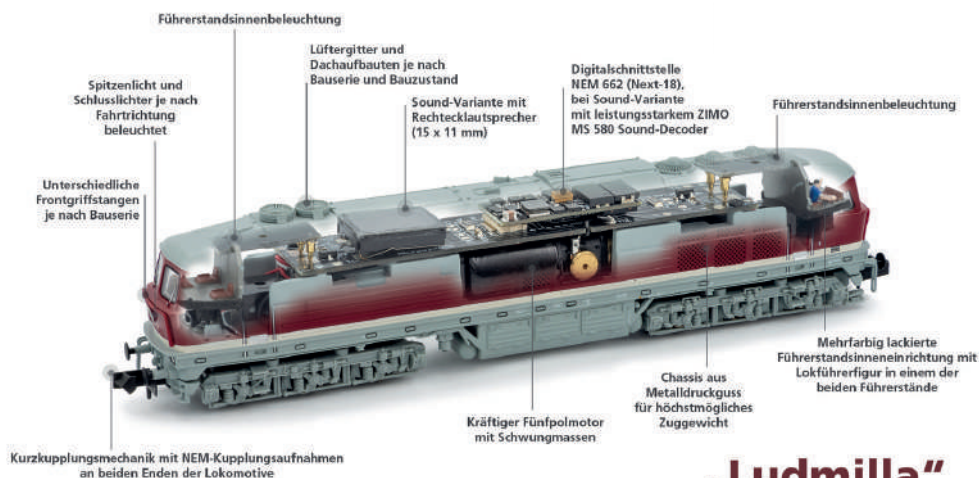

„Ludmilla“

HN2600/HN2600S

DR, sechssachsige Diesellokomotive 142 002-5 in roter Farbgebung mit grauem Dach, Ep. IV



- Chassis aus Metalldruckguss für höchstmögliches Zuggewicht
- Kräftiger Fünfpolmotor mit Schwungmassen
- Kurzkupplungsmechanik mit NEM-Kupplungsaufnahmen an beiden Enden der Lokomotive
- Spitzenlicht und Schlusslichter je nach Fahrtrichtung

HN2599/HN2599S

DR, sechssachsige Diesellokomotive 132 483-9 in roter Farbgebung mit grauem Dach, Ep. IV



- beleuchtet
- Unterschiedliche Frontgriffstangen je nach Bauserie
- Führerstandsinnenbeleuchtung
- Lüftergitter und Dachaufbauten je nach Bauserie und Bauzustand
- Sound-Variante mit Rechtecklautsprecher (15 x 11 mm)

HN2601/HN2601S

DB Bahnbau, Diesellokomotive 233 493-6 in gelber Farbgebung, Ep. VI



- Digitalschnittstelle NEM 662 (Next-18), bei Sound-Variante mit leistungsstarkem ZIMO MS 580 Sound-Decoder
- Führerstandsinnenbeleuchtung
- Mehrfarbig lackierte Führerstandsinneneinrichtung mit Lokführerfigur in einem der beiden Führerstände



HN4421

DR, 3-tlg. Set OSShD Typ B Reisezugwagen in grüner Lackierung, bestehend aus 1 x WLAB, 1 x AB und 1 x Bc, Ep. III



HN4422

DR, 3-tlg. Set OSShD Typ B Reisezugwagen in grüner Lackierung, bestehend aus 1 x WR und 2 x B, Ep. III



HN4423

DR, 3-tlg. Set OSShD Typ B Reisezugwagen „Spree-Alpen-Express“ in grün/roter Lackierung, bestehend aus 1 x Bc und 2 x WLAB, Ep. IV



HN4424

DR, 3-tlg. Set OSShD Typ B Reisezugwagen „Spree-Alpen-Express“ in grün/roter Lackierung, bestehend aus 1 x WR und 2 x DDm, Ep. IV



HN2603/HN2603D

Straßenbahn, Typ DUEWAG GT6, Version Essen in gelb/blauer Lackierung, Ep. IV-V



HN2603/D - DUEWAG GT6, gelb/blauer Lackierung



HN2604/HN2604D

Straßenbahn, Typ DUEWAG GT6, Version Essen, „König Pilsener“, Ep. IV-V



HN2604/D - DUEWAG GT6, „König Pilsener“



HN2605/HN2605D

Straßenbahn, Typ DUEWAG GT6, „Coca-Cola“, Ep. IV-V



HN2605/D - DUEWAG GT6, „Coca-Cola“

Re 4/4 der BLS

GIPFELSTÜRMER

HN2626/HN2626S

BLS, vierachsige elektrische Mehrzwecklokomotive
Re 4/4 161 „Domodossola“, braun, Ep. IV-V



Spitzenbeleuchtung



Schweizer Rücklicht



Führerstandsinnenbeleuchtung (nur
Soundversionen HN2626S/27S/28S)



Hochwertige Verpackung mit Chromaufschrift
und Metallbox

HN2627/HN2627S

BLS, vierachsige elektrische Mehrzwecklokomotive
Re 4/4 173 „Lötschental“, braun, Ep. IV-V

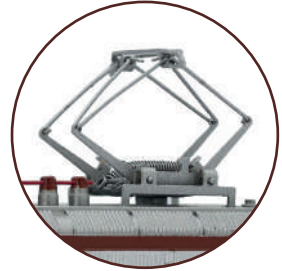

Scherenstromabnehmer



Booklet zur Geschichte dieser erfolgreichen
Lokomotivbaureihe

HN2628/HN2628S

BLS, vierachsige elektrische Mehrzwecklokomotive
Re 4/4 192 „Spiez“, mit Einholmstromabnehmer, braun,
Ep. IV-V

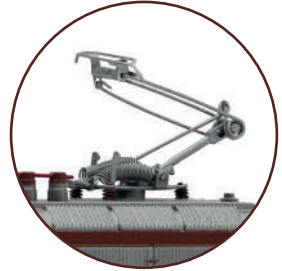

Einholmstromabnehmer



Schlüsselanhänger aus Metall in Form einer
Re 4/4 der BLS



HN2632/HN2632S

RENFE, locomotora diesel 321-025, con quitanieves, decoración amarillo-gris con numerales amarillos, ép. V



HN2633/HN2633S

ADIF, locomotora diesel 321-011, con quitanieves, decoración verde-blanco, ép. VI



HN6576

ADIF, set de 3 unidades, decoración verde, compuesto de 2 vagones carrados de 2 ejes J2 y 1 coche SSV-500, ép. VI



HN2634/HN2634S

ALSA, locomotora diesel 2150, decoración verde-amarillo, ép. VI



HN2633

HN6576-1

HN6576-2

HN6576-3



HN3503

SBB, set di 3 carrozze intermedie per HN2470, livrea "Cisalpino", ép. VI



HN3504

FS, set di 3 carrozze intermedie per HN2471, livrea "Cisalpino", ép. VI



HN3506

FS, set di 3 carrozze intermedie per HN2473, livrea "AV Frecciargento", ép. VI



 **HN4349**

 SNCF, coffret de 2 unités, fourgon porte-automobiles DD DEV 66, livrée bleu, ép. IV-V



 **HN4351**

RENFE, set de 2 unidades, vagón plataforma DDMA para coches, decoración blanca, ép. V



 **HN4352**

DB AG, 2-tlg. Set, Autotransportwagen DDm, in grüner Lackierung, Ep. V



 **HN4355**

 SNCF/RENFE, coffret de 6 unités, Talgo «Francisco de Goya» (Paris – Madrid), livrée bleue/blanche, ép. V



 **HN4356**

 SNCF/RENFE, coffret de 3 voitures supplémentaires, Talgo «Francisco de Goya» (Paris – Madrid), livrée bleue/blanche, composé de 1 voiture restaurant, 1 voiture bar, 1 voiture «superreclinable», ép. V



 **HN4359**

DB, 4-tlg. Set Reisezugwagen in blauer, grüner und blau/roter Lackierung, bestehend aus 1 x Aüm, 2 x Büm und 1 x ARüm²¹⁷, Ep. IV





HN4360

DB AG, 4-tlg. Set Reisezugwagen „InterCity“ in rot/weißer Lackierung, bestehend aus 1 x Apmz, 1 x Bm, 1 x Bpmz und 1 x Armz, Ep. V



HN4361

ALEX, Speisewagen ARm217, in blau/weißer Lackierung, Ep. VI



HN4364

DB, 3-tlg. Set Reisezugwagen „TEE Bavaria“ in rot/beiger Lackierung, bestehend aus 1 x Apm¹²¹, 1 x Avm¹¹¹ und 1 x ARDm¹²⁷, Ep. IV



HN4365

DB AG, 3-tlg. Set Reisezugwagen „Rollende Raststätte“, in orientrot/weißer Lackierung, bestehend aus 2 x Avm und 1 x WGM, Ep. V



HN4366

DB AG, 3-tlg. Set Nahverkehrswagen, in mintgrün/weißer Lackierung, bestehend aus 1 x Steuerwagen, 1 x Aby und 1 x By, Ep. V



HN4367

DB AG, 3-tlg. Set Nahverkehrswagen, in mintgrün/weißer Lackierung, bestehend aus 1 x ABDomsb und 2 x Bom, Ep. V



HN4368

MRB, 3-tlg. Set Nahverkehrswagen, in silber/blauer Lackierung, bestehend aus 1 x Bybdzf und 2 x Bom, Ep. VI



- LüP 3 x 165 mm
- Nachbildung der Drehgestelle BA Görlitz V
- mehrfarbige Inneneinrichtung
- Kurzkupplung an jeweils beiden Wagenenden
- beleuchtete Zugzielanzeige am Steuerwagen
- Lichtwechsel weiß/rot je nach Fahrtrichtung am Steuerwagen
- 6-polige Digitalschnittstelle nach NEM 651 im Steuerwagen

- LüP 3 x 165 mm
- Nachbildung der Drehgestelle BA GP200
- mehrfarbige Inneneinrichtung
- Kurzkupplung an jeweils beiden Wagenenden

HN4383

SNCF, coffret de 3 voitures DEV A0, livrée verte, composé de 1 voiture A9 et 2 voiture B10, ép. III



HN4390

 EuroCity „Mozart”, 3-tlg. Set Reisezugwagen, bestehend aus 1 1. Klasse Wagen der ÖBB in oranger Lackierung, 1 1. Klasse Wagen der SNCF in grauer Lackierung und 1 Speisewagen der DB in beige/roter Lackierung, Ep. IV-V



HN4396

RENFE, set de 3 coches «Al-Andalus», compuesto de 2 coches restaurante WR y 1 furgón, ép. IV-V



- La longitud entre tope es de 459 mm
- Modelo con interiores detallados
- Tiene un mecanismo elástico para enganche corto



HN4384

SNCF, voiture couchettes DEV A0 B10c10, livrée verte, ép. III



HN4391

 EuroCity „Mozart”, 3-tlg. Set ÖBB 2. Klasse Reisezugwagen in oranger und roter Lackierung, Ep. IV-V



HN4405

SNCF, coffret de 2 voitures-lits T2, livrée bleue avec logo «nouille», ép. IV-V



Le modèle réduit à l'échelle N
Voiture Lits T2 SNCF logo Tallon (HN4405)
Fabrique par la société:

ARNOLD

A été élu modèle de l'année 2023
dans la catégorie matériel remorqué voyageurs industriel
par les membres du Forum du N

Le Forum du N, forum de discussion consacré au modélisme ferroviaire à l'échelle N (1/160)
Adresse internet : <https://le-forum-du-n.fr/n/>

HN4385

SNCF, coffret de 3 voitures DEV A0, livrée verte avec logo encadré, composé de 1 voiture A9 et 2 voiture B10, ép. IV



HN4395

FS, set di 3 carrozze UIC-Z Eurofima, livrea "C1", composto da 1 carrozza di 1a classe e 2 carrozze di 2a classe, ep. IV-V



- Gancio corto con cinematismo a norma NEM per un aggancio realistico e fluido
- Interni dettagliati per un'esperienza visiva ancora più immersiva.

HN4406

SNCB, coffret de 3 unités composé de 1 voiture-lits T2 en livrée bleue, 1 fourgon porte-automobiles DD DEV en livrée bleu et 1 voiture Bc 16 en livrée bleu/rouge, ép. IV-V

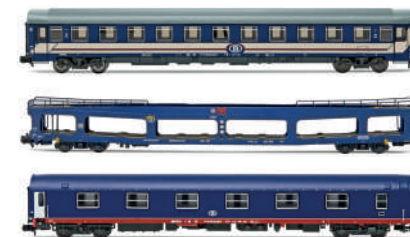

- Une voiture-lits T2 en livrée bleue
- Un fourgon porte-automobiles DD DEV en livrée bleu
- Une voiture Bc 16 en livrée bleu/rouge



HN4409

DR, 2-tlg. Set, Autotransportwagen DDM in blauer Lackierung, Ep. IV



- Länge über Puffer in 330 mm
- Kurzkupplungs-Mechanik eingebaut



HN4410

DB AG, 2-tlg. Set, Autotransportwagen DDM in blauer Lackierung, Ep. V



HN4411

SNCF, coffret de 2 unités, fourgon porte-automobiles DD DEV 66, livrée verte avec logo «encadré» blanc, ép. IV



HN4412

SNCF, coffret de 2 unités, fourgon porte-automobiles DD DEV 66, sans protection supérieure, livrée verte avec logo «casquette» blanc, ép. V



HN4413

RENFE, set de 2 unidades, vagón plataforma DDMA para coches, con rejillas de protección, decoración original, ép. IV



HN4414

RENFE, vagón plataforma MMA para coches, decoración roja "Pecovasa", ép. V



HN4417

DBP, 2-tlg. Set 4-achs. Postwagen Post-mrz, in grüner Lackierung, Ep. IV



HN4418

DBP, 2-tlg. Set 4-achs. Postwagen Post-mrz, in beige/blauer Lackierung, Ep. IV



HN4419



RailAdventure, 2-tlg. Set 4-achs. Kuppelwagen (ex Post-mrz) in grauer Lackierung, Ep. VI



HN4420

DR, 4-tlg. Set OSShD Typ B Reisezugwagen „Touristen-Express“ in blauer Lackierung, bestehend aus 2 x WLAB, 1 x WR und 1 x Salonwagen, Ep. III



HN4428

SVG, 4-achs. Postwagen (ex Post-mr-a), Ep. V



HN4435

DR, 2-tlg. Set Reisezugwagen „Städte-Express“, in orange-beiger Farbgebung, bestehend aus 1 x 1.Klasse Wagen und 1 x 2.Klasse Wagen, Ep. IV



HN4425

Deutsche Bundespost, 2-tlg. Set 4-achs. Postwagen Post-mrz in grüner Lackierung mit großen „DBP“-Logos, Ep. IV-V



HN4437

3-tlg. Set Reisezugwagen „D242 Paris – Berlin – Warszawa“, bestehend aus 1 x DB Am in blau-beiger Farbgebung und 2 x SNCF DEV AO B10, Ep. IV



- besteht aus einem Reisezugwagen Am 1. Klasse der DB und zwei Liegewagen B10c10 der SNCF
- Kurzkupplungskinematik und Kupplungsaufnahme nach NEM 355
- feine Lackierung und Bedruckung

HN4440

SNCF, coffret de 3 voitures TEE « Cisalpin », Milan - Paris, livrée argent, composé de 1 voiture Vru, 1 voiture A3rtu et 1 voiture A8u, ép. IV



HN4426

Lokomotion, 4-achs. Gerätewagen (ex Post-mrz) „Zebrawagen“ in grauer Lackierung mit blauem Streifen, Ep. VI



HN4436

3-tlg. Set Reisezugwagen „D242 Paris – Berlin – Warszawa“, bestehend aus 1 x DR WRm¹³⁰ in roter Farbgebung und 2 x DR Bm in grün-beiger Farbgebung, Ep. IV



- besteht aus Reisezugwagen Bm 2. Klasse („lange Halberstädter) der DR und einem Speisewagen WRm der DR
- vorbildentsprechend sind die Modelle mit Nachbildung der „GP 200“-Drehgestelle ausgestattet
- Kurzkupplungskinematik und Kupplungsaufnahme nach NEM 355
- feine Lackierung und Bedruckung

HN4441

SNCF, coffret de 3 voitures TEE « Cisalpin », Milan - Paris, livrée argent, composé de 1 voiture A4Dtux, 1 voiture A8u et 1 voiture A8tu, ép. IV



 **HN4442** SNCF, voiture TEE « Cisalpin » A8u, Milan - Paris, livrée argent, ép. IV **HN4443** SNCF, voiture TEE « Cisalpin » A8tu, Milan - Paris, livrée argent, ép. IV **HN4444** SNCF, coffret de 3 voitures TEE « Paris - Ruhr », livrée argent, composé de 1 voiture A4Dtux, 1 voiture Vru et 1 voiture A3rtu, ép. IV **HN4445** SNCF, voiture TEE « Paris - Ruhr » A8u, livrée argent, ép. IV **HN4446**

SNCF, coffret de 2 unités, train de maintenance, composé de 1 voiture ex B10 et 1 wagon G4, ép. IV-V

 **HN4448**

SNCF, coffret de 2 voitures DEV AO B9, livrée verte/grise avec logo « Encadré », ép. IV

 **HN4449**

SNCF, coffret de 2 voitures DEV AO B10, livrée verte/grise avec logo « Nouille », ép. IV

 **HN4460**

RENFE, set de 3 coches CIWL «Castellano Expreso», compuesto de 1 furgón y 2 coches camas Lx, ép. IV

 **HN4461**

RENFE, set de 3 coches CIWL «Castellano Expreso», compuesto de 1 coche restaurante y 2 coches camas Lx, ép. IV



Les nouveaux modèles Arnold suivent les modèles des tranches U55, U56, U57 et U59, les « DEV AO longues ».
Elles faisaient partie du paysage ferroviaire français jusqu'à la fin des années 90, mais on les trouvait également dans le trafic international, comme par exemple dans le D242 Paris – Berlin – Warszawa (coffret Arnold HN4437).



HN4454

RENFE, set de 3 coches 5000, decoración "Regionales", compuesto de 1 coche "Manso" y 2 coches de compartimentos, ép. V



HN4455

ALSA, set de 2 coches 6000, decoración verde oliva, ép. VI



Descubre el modelo a través de la revisión de Modelismo 2.0



HN4456

RENFE, set de 3 unidades, «Tren Taller Granada», decoración amarillo, compuesto de 1 coche 5000 y 2 vagones cerrados J2, ép. V

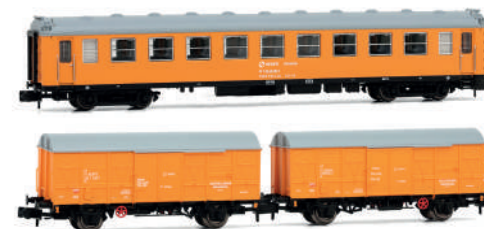

HN4457

RENFE, set de 3 unidades, «Tajo de Via», decoración azul, compuesto de 1 coche 5000 y 2 vagones cerrados J3, ép. IV-V



HN4467



FS, set di 3 carrozze "Alpen-Express" Roma - Monaco di Baviera, 1 x WR ex CIWL + 1 x Eurofima 2a cl. livrea C1 + 1 x UIC-X '64 2a cl. livrea grigia, ep. IV



HN4468



DB/FS, set di 3 carrozze "Alpen-Express" Roma - Monaco di Baviera, composto da 1 x Avvmz111 DB rosso/beige + 1 x Eurofima 2a cl. livrea C1 + 1 x UIC-X '64 2a cl. livrea grigia, ep. IV



HN4469

FS, set di 3 unità, treno espresso, composto da 1 x CIWL WR + 1 x UIC-X '64 1° cl. + 1 x UIC-X '64 2° cl. in livrea grigia, ep. IV



HN4473

SNCF, coffret de 3 voitures Coca-Cola « Train de Noël » de 2010, ép. VI





HN6517

AZVI, set de 2 wagones cerrados de 2 ejes, decoración amarillo, compuesto de 1 vagón J2 y 1 vagón J3, ép. V-IV



HN6521

DR, 2-tlg. Set gedeckte Güterwagen mit Bretterwänden Gs, Ep. IV



HN6522

DB, 2-tlg. Set gedeckte Güterwagen mit Bretterwänden Gs, Ep. IV



HN6525

SNCF, coffret de 2 wagons-citerne à 2 essieux à gaz, livrée gris avec bande orange, ép. III



HN6532

DR, 2-tlg. Set 4-achs. offene Güterwagen Eaos, in brauner Lackierung, beladen mit Schrott, Ep. IV



HN6533

DB, 2-tlg. Set 4-achs. offene Güterwagen Eaos, in brauner Lackierung, beladen mit Schrott, Ep. IV



HN6534

STLB, 2-tlg. Set 4-achs. offene Güterwagen Eaos, in grau/grün/roter Lackierung, beladen mit Schrott, Ep. V-VI



HN6535

SNCF, 2-tlg. Set 4-achs. offene Güterwagen Eaos, in grauer Lackierung, beladen mit Schrott, Ep. IV



HN6537

ERR, 2-unit set of 4-axle tank wagons, green/grey and light/dark blue livery, period VI



 **HN6539**

FS, set di 2 carri cisterna a 4 assi Zags/Zas, livrea grigia chiara "Sogetank" con e senza striscia arancio, ep. V



 **HN6540**

FS, set di 2 carri cisterna a 4 assi Zagkks, livrea bianca "Air Liquide" con striscia arancio, ep. V



 **HN6548**

SNCF, coffret de 2 wagons-trémies à 4 essieux Faos pour le transport du charbon, «S.G.W.», ép. IV



 **HN6561**

FS, carro cisterna a 4 assi Us, livrea blu, "Ausiliare", ep. IV



 **HN6562**

DB AG, 3-tlg. Set Selbstentladewagen der Bauart Fals164, braune Farbgebung, Ep. V



 **HN6563**

DR, 3-tlg. Set Selbstentladewagen der Bauart Fal-zz ohne Oberkasten, braune Farbgebung, Ep. IV



 **HN6565**

PKP Cargo, 3-tlg. Set Selbstentladewagen der Bauart Falls in blauer Farbgebung, Ep. VI



- HN6562
 - Mehr als 1000 Wagen waren bei der DB AG im Einsatz
 - Wurden hauptsächlich für den Kohletransport eingesetzt
 - Drehgestelle Typ Y 25
 - Feine Detaillierung und Bedruckung
 - Nachbildung der inneren Stützbleche mit Ätzteilen
- HN6563
 - Umbau aus Selbstentladewagens mit hohem Aufbau
 - Rückbau des Oberwagens zur Verringerung des Laderaums
 - Einsatz für den Erztransport bei der SDAG Wismut
 - Drehgestelle Typ Niesky
 - Genaue Detaillierung und Bedruckung
 - Nachbildung der inneren Stützbleche mit Ätzteilen
- HN6565
 - Modell des PKP Cargo-Wagens für Kohletransporte aus polnischen Revieren nach Deutschland und Österreich
 - Ausgestattet mit Drehgestellen der Bauart Niesky
 - Detailliert und originalgetreu mit Ätzteilen für die inneren Stützbleche

 **HN6566**

DB, 2-achs. Flachwagen Kls in brauner Lackierung, beladen mit 2 x 20' Container „DB“, Ep. IV





HN6567

DR, 2-tlg. Set Bahndienstwagen in grüner Lackierung, bestehend aus 1 x 2-achs. Rungenwagen und 1 x 2-achs. gedeckte Güterwagen, Ep. IV



HN6568

DB, 2-tlg. 2-achs. gedeckte Güterwagen Gmhs 55, in brauner Lackierung, „Düngemittel“, Ep. III



HN6570

SNCF, coffret de 2 wagons à 2 essieux Kv Permaplex, livrée marron, ép. III



HN6571

SNCF, coffret de 2 wagons fermés à 2 essieux Kv avec parois en bois, livrée marron, "Provence Express", ép. III



HN6572

SNCF, coffret de 2 wagons fermés à 2 essieux G4 Permaplex, livrée marron, "Aquitaine Express", ép. IV



HN6573

FS, set di 2 carri chiusi a 2 assi Gs, livrea marrone, ep. III



HN6574

FS, set di 2 carri chiusi a 2 assi Gs, livrea marrone, ep. IV



HN6575

RENFE, set de 2 vagones cerrados de 2 ejes J2, decoración original, ép. III-IV



HN6577

RENFE, set de 2 vagones cerrados de 2 ejes, decoración verde/amarilla, "Tren Taller Oviedo", compuesto de 1 vagón Gbs y 1 vagón ORE1, ép. IV-V



 **HN6581**

RENFE, set de 2 vagones plataforma de 2 ejes, decoración rojo óxido, cargados con sacos de tabaco, ép. IV



 **HN6582**

SNCF, wagon porte-conteneurs à 4 essieux Novatrans Sgnss, livrée gris, chargé avec 2 Coil-Container de 22' «T.T.S.», ép. V



 **HN6584**

SNCF, coffret de 2 wagons porte-conteneurs à 4 essieux Novatrans Sgss, livrée gris, chargés avec conteneurs de 45' «Trans-Fer», ép. V



 **HN6595**

DB, 2-tlg. Set 2-achs. Silowagen Ucs in grauer Lackierung, „Höchst“, Ep. IV



 **HN6597**

FS, carro silo a 2 assi, livrea blu, „Ausiliare“, ep. IV



 **HN6598**

D-KFH, 4-achs. isolierter Gaskesselwagen in weiß/orangefarbener Lackierung, „Carbo“, Ep. V-VI



 **HN6602**

SNCF, coffret de 3 wagons-tombereaux Eamnos, ép. VI



 **HN6603**

DB, 2-tlg. Set 2-achs. Gaskesselwagen Zgs, „Linde“, Ep. IV



DB, 2-tlg. Set 2-achs. Gaskesselwagen, „Rommenhüller Kohlendioxid“, Ep. IV



 **HN6605**

SNCF, wagon-citerne isolé à 4 essieux, "Nacco/Solvay", ép. V



 **HN6606**

SNCF, wagon-citerne isolé à 4 essieux Uahs, "Algeco", ép. IV-V



 **HN6607**

SNCF, coffret de 2 wagons-citernes à 3 essieux, « Algeco », ép. III



 **HN6608**

SNCF, coffret de 2 wagons-citernes à 3 essieux, « Total », ép. III



 **HN6609**

SNCF, coffret de 2 wagons-citernes à 3 essieux Uh, « Shell », ép. IV



 **HN6610**

SNCF, coffret de 2 wagons-citernes à 3 essieux Uh, « Esso », ép. IV



 **HN6611**

RENFE, set de 2 vagones cisternas de 3 ejes, decoración gris, «Koipe», ép. IV



 **HN6612**

RENFE, set de 2 vagones cisternas de 3 ejes, decoración gris, «Campsa», ép. IV



 **HN6613**

RENFE, set de 2 vagones cisternas de 3 ejes, decoración gris, «Elosua», ép. IV



 **HN6615**

SNCF, coffret de 2 wagons trémies à 4 essieux Faaos pour le transport du charbon, « S.G.W. / STEMI », ép. IV



 **HN6616**

SNCF, coffret de 2 wagons trémies à 4 essieux Faaos pour le transport du charbon, « S.G.W. / SITRAM », ép. IV



 **HN6617**

RENFE, set de 2 wagons tolva de 4 ejes Faaos, decoración marrón, «Transfesa», ép. IV-V



 **HN6618**

ACCIONA, set de 2 wagons tolva de 4 ejes Faaos, decoración marrón, ép. VI



 **HN6619**

SNCF, coffret de 2 wagons trémies à 4 essieux avec parois rondes pour le transport de céréales, « France Luzerne », ép. IV



 **HN6620**

SNCF, coffret de 2 wagons trémies à 4 essieux avec parois rondes et planes pour le transport de céréales, livrée grise/jaune, « Transcéréales S.H.G.T. Roquette », ép. IV



 **HN6623**

RENFE, vagón tolva de 4 ejes TT5 con paredes planas, decoración rojo oxido, «Metransa», ép. IV



 **HN6624**

RENFE, set de 2 wagons tolva de 4 ejes TT5 con paredes planas, decoración verde, ép. V



 **HN6626**

DB, 4-achs. Schwenkdachwagen mit gewölbten Silowänden für Getreidetransport, „Aurora“, Ep. V





HN6628

RENFE, vagón cisterna aislado de 4 ejes para cianuro de hidrógeno, decoración amarilla/gris, «Saltra», ép. IV



HN6630

D-VTG, 4-achs. isolierter Kesselwagen in Chrom-Lackierung, „VTG“, Ep. VI



HN6631

D-GATXD, 4-achs. isolierter Kesselwagen in Chrom-Lackierung, „GATX“, Ep. VI



HN6632

ÖBB, 4-achs. isolierter Kesselwagen in grau/orange/weißer Lackierung, „Turmöl“, Ep. IV-V



HN6636

SNCF, wagon à parois coulissantes à 4 essieux Habbins, « FRET », ép. IV-V



HN6637

F-ERSA, wagon à parois coulissantes à 4 essieux Habbins, « Ermewa », ép. VI



HN6638

CH-TWA, 4-achs. Schiebewandwagen Habbins in silber/schwarzer Lackierung, „Transwaggon“, Ep. VI



HN6639

DB, 2-tlg. Set 2-achs. Silowagen in grauer Lackierung, „Dyckerhoff“, Ep. IV



HN6640

DR-Miet, 2-tlg. Set 2-achs. Silowagen Ucs in grauer und blauer Lackierung, „VTG“, Ep. IV



HN6641

SNCF, wagon-silo à 2 essieux Ucs, « Fixit », ép. V



HN6644

DB, 2-achs. gedeckte Güterwagen Gs206 in roter Lackierung, „Früh-Kölsch“, Ep. IV



HN6649

SNCF/Novatrans, wagon porte-conteneurs à 4 essieux Sgss, livrée grise, chargé avec un conteneur de 45' « Geodis », ép. V



 **HN6650**

SNCF/Novatrans, wagon porte-conteneurs à 4 essieux Sgss, livrée grise, chargé avec 2 Coil-Container de 22' « Tipes », ép. V



 **HN6651**

RENFE, vagón porta contenedores de 4 ejes, decoración azul, cargado con 3 contenedores de 20' «Adif», ép. VI



 **HN6653**

VTG, 4-achs. Containerwagen, beladen mit 45' Container „ONE“, Ep. VI



 **HN6654**

FS, carro porta container a 4 assi Sgnss, livrea marrone, caricato con 2 container “Spedirail” da 22 piedi, ep. VI



 **HN6655**

FS CEMAT, carro porta container a 4 assi Sgnss, livrea verde, caricato con 2 coil container “Gruppo Bernardini” da 22 piedi, ep. VI



 **HN6656**

FS, carro porta container a 4 assi Sgnss, livrea marrone, caricato con container “Italia” da 45 piedi, ep. VI



 **HN6657**

2-tlg. Set 4-achs. Containerwagen in grüner Lackierung, beladen mit 45' Container „Nothegger“, Ep. V-VI



 **HN6658**

4-achs. Containerwagen, beladen mit 2 x 22' Coil-Container „B+R logistik Bedburg“, Ep. V-VI



 **HN6659**

4-achs. Containerwagen, beladen mit 2 x 22' Coil-Container „Rheinkraft“, Ep. V-VI



 **HN6660**

RENFE, set de 2 vagones cerrado de 2 ejes J300.000, decoración gris, «Gran Velocidad», ép. III



 **HN6666**

RENFE, set de 2 vagones cerrados J3, decoración “Nitrato de Chile”, ép. III



 **HN6675**

SNCF, coffret de 2 wagons-citernes transport de vin à 3 essieux, « SGLT SEWAR », ép. IV



 **HN6676**

SNCF, coffret de 2 wagons-citernes à 3 essieux « AVIA », ép. IV



 **HN6677**

SNCF, coffret de 2 wagons-citernes à 3 essieux « Petroles de l'Ouest », livrée grise, ép. IV



 **HN6672**

RENFE, set de dos vagones cisterna PR de tres ejes, decoración "Savesa", ép. IV



 **HN6673**

RENFE, set de dos vagones cisterna PR de tres ejes, decoración "Borges", ép. III



 **HN6674**

RENFE, set de dos vagones cisterna PR de tres ejes, decoración "CAMPSA", ép. III



 **HN6696**

SNCF, coffret de 2 wagons bâchés à 2 essieux type K70 Kils, livrée bleue, « FRET », ép. IV-V



 **HN6697**

ÖBB, 2-tlg. Set zweiachsiger Schiebeplanenwagen der Bauart Kils, „Rail Cargo Austria“, grau-rote Farbgebung, Ep. V-VI



 **HN6698**

FS, carro articolato doppio a 2+2 assi con telone, tipo Laails 2, livrea blu "Ausiliare Milano", ép. IV-V



 **HN6699**

DB AG, 2-tlg. Set zweiachsiger Schiebeplanenwagen der Bauart Kijls, verkehrsrote Farbgebung, Ep. V-VI



HN0503

Arnold (N 1: 160), 10-Einheit Packung ARNOLD Standardkoppler Köpfe





Photo: Thilo Angelkorte

Inhalt • Index

Diesellokomotiven120
Diesel locomotives.....120

Güterwagen 124
Wagons.....124

Bereits lieferbar 128
Still available.....128



www.arnoldmodel.com



Willkommen in der faszinierenden Welt von Arnold Spur TT!

Auch 2025 setzen wir auf Innovation und Detailtreue. Unsere Highlights in diesem Jahr umfassen die beeindruckende Class 66, eine moderne Diesellokomotive mit internationalem Flair, sowie spannende neue Varianten der beliebten Vossloh DE 18, die bereits 2024 für Begeisterung sorgte. Darüber hinaus präsentieren wir neue Modelle der bekannten Fährbootcontainerwagen, die perfekt zur Class 66 und der DE 18 passen. Mit diesen Neuheiten bieten wir Ihnen eine noch größere Vielfalt und authentische Modelle für Ihre Spur-TT-Anlage. Entdecken Sie Qualität, die bewegt – Arnold Spur TT.

HN9073/HN9073S



NEW



DB Cargo, Diesellokomotive Vossloh DE 18, rot/grau Farbgebung

DB Cargo, locomotora diésel Vossloh DE 18, decoración roja/gris

DB Cargo, locomotiva diesel-elettica Vossloh DE 18, livrea rossa/grigia

DB Cargo, locomotive diesel-électrique Vossloh DE 18, livrée rouge/grise

DB Cargo, diesel locomotive Vossloh DE 18, red/grey livery



HN9072/HN9072S



NEW



BASF, dieselelektrische Lokomotive Vossloh DE 18, orange/graue Farbgebung

BASF, locomotora diésel-eléctrica Vossloh DE 18, decoración naranja/gris

BASF, locomotiva diesel-elettrica Vossloh DE 18, livrea arancio/grigia

BASF, locomotive diésel-eléctrique Vossloh DE 18, livrée orange/grise

BASF, diesel-electric locomotive Vossloh DE 18, orange/grey livery

*Fotomontage / Fotomontaje /
Fotomontaggio / Photomontage*



Die Diesellokomotiven des Typs DE 18 von Vossloh

Bei der DE 18 handelt es sich um die erste Lokomotive aus dem ehemaligen MaK-Werk Kiel seit der Einstellung der Produktion der DE 1002 im Jahr 1993. Seit ihrer Markteinführung 2014 hat Vossloh mehr als 200 Lokomotiven des Typs DE 18 an Kunden in verschiedenen europäischen Ländern verkauft, die heute zuverlässig ihren Dienst sowohl im Rangier- als auch Streckenbetrieb leisten – so auch für die DB, die SNCF und die italienische FS.

Das neue Arnold-Spur-TT-Modell der DE 18 setzt neue Maßstäbe in Detailtreue und Funktionalität. Es besticht durch feinste Gravuren und eine authentische Nachbildung der markanten Linien der Original-Lokomotive. Der leise laufende kernlose Motor ermöglicht ein realistisches Fahrverhalten, während die robuste Konstruktion mit Zinkdruckguss-Chassis für hohe Stabilität sorgt. Mit dieser Kombination aus Qualität und Detailtreue ist die DE 18 ein Highlight für jede Spur-TT-Anlage.

Die neuen Vossloh DE 18 von Arnold TT in Stichpunkten:

- Neuentwicklung mit vorbildentsprechenden Bauartunterschieden zu den bereits bekannten Modellen
- Chassis aus Zinkdruckguss, Gehäuse auch hochwertigem, fein graviertem Kunststoff
- Fünfpoliger Hochleistungsmotor mit Schwungmassen
- Alle vier Achsen angetrieben
- Stromabnahme über alle Räder der Lok
- Länge über Puffer: 142 mm
- Mindestradius: 310 mm
- Spitzenbeleuchtung mit der Fahrtrichtung wechselnd
- Rote Schlussleuchten mit der Fahrtrichtung wechselnd und im Digitalbetrieb separat schaltbar
- Kurzkupplungskulissen beidseitig
- Kupplungsaufnahmen nach NEM 355 beidseitig
- Digitalschnittstelle nach NEM 662 („Next-18“)

HN9070/HN9070HM

HMIDCC

VI

NEM 662

179

K

K

K

K

K

K

NEW



DB AG, dieselelektrische Lokomotive Class 77, rote Farbgebung

DB AG, locomotora diésel-eléctrica clase 77, decoración roja

DB AG, locomotiva diesel-elettrica classe 77, livrea rossa

DB AG, locomotive diesel-électrique classe 77, livrée rouge

DB AG, diesel-electric locomotive class 77, red livery

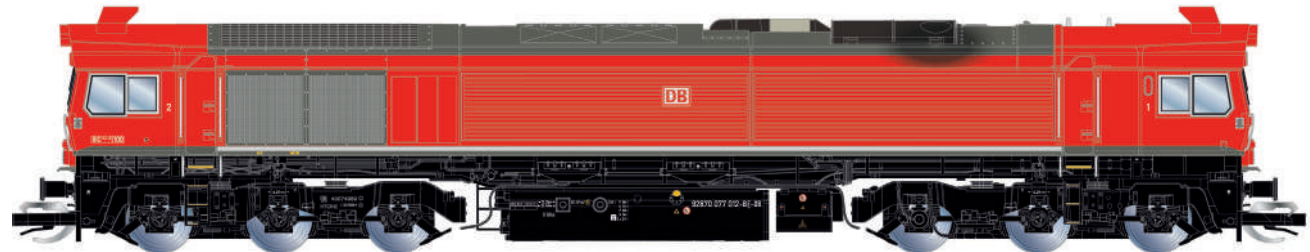

Die neue Class 66/77 von Arnold TT in Stichpunkten:

- Vollständige Neuentwicklung mit vorbildentsprechenden Bauartunterschieden zwischen Class 66 und Class 77
- Chassis aus Zinkdruckguss, Gehäuse auch hochwertigem, fein graviertem Kunststoff
- Fünfpoliger Hochleistungsmotor mit Schwungmassen
- Alle sechs Achsen angetrieben
- Stromabnahme über alle Räder der Lok
- Länge über Puffer: 179 mm
- Mindestradius: 310 mm
- Spitzenbeleuchtung und rote Schlussleuchten mit der Fahrtrichtung wechselnd und im Digitalbetrieb separat schaltbar
- Führerstandsbeleuchtung im Digitalbetrieb separat schaltbar
- Digitalversionen ab Werk mit Hornby HM7000 Bluetooth-Sounddecoder, steuerbar über die HMIDCC-App ohne Digitalzentrale
- Kurzkupplungskulissen beidseitig
- Kupplungsaufnahmen nach NEM 355 beidseitig
- Digitalschnittstelle nach NEM 662 („Next-18“)

HN9069/HN9069HM

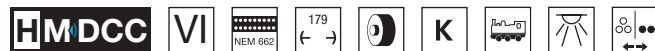

NEW



Heavy Haul Power, dieselelektrische Lokomotive Class 66, graue Farbgebung

Heavy Haul Power, locomotora diésel-eléctrica clase 66, decoración gris

Heavy Haul Power, locomotiva diesel-elettrica classe 66, livrea grigia

Heavy Haul Power, locomotive diesel-électrique classe 66, livrée grise

Heavy Haul Power, diesel-electric locomotive class 66, grey livery



Vorbildgerecht mit Lampen der europäischen Class 66



HN9071/HN9071HM

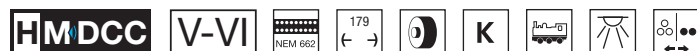

NEW



HGK, dieselelektrische Lokomotive Class 66, rote Farbgebung mit gelber Front

HGK, locomotora diésel-eléctrica clase 66, decoración roja con frente amarillo

HGK, locomotiva diesel-elettrica classe 66, livrea rossa con frontale giallo

HGK, locomotive diesel-électrique classe 66, livrée rouge avec avant jaune

HGK, diesel-electric locomotive class 66, red livery with yellow front

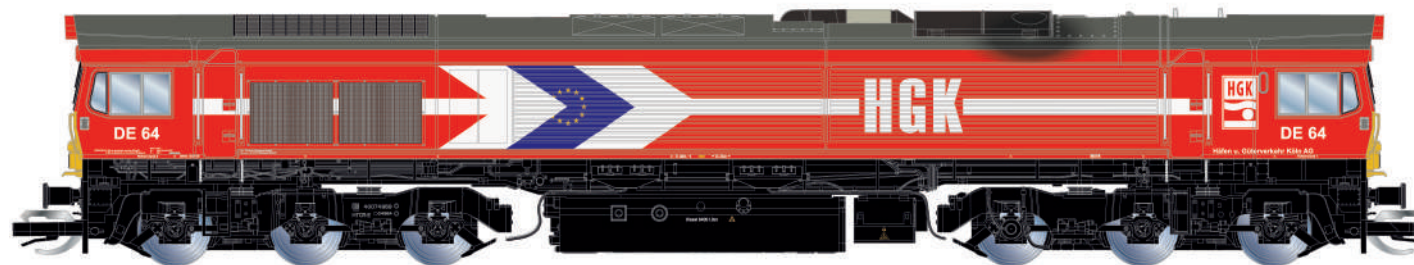

HN9754

IV 97 K



DR, Kühlwagen „VEB Fischkombinat Rostock“

DR, vagón refrigerado de 2 ejes “VEB Fischkombinat Rostock”

DR, carro refrigerante “VEB Fischkombinat Rostock”

DR, wagon réfrigéré « VEB Fischkombinat Rostock »

DR, 2-axle refrigerated wagon “VEB Fischkombinat Rostock”



NEW

Fotomontage / Fotomontaje / Fotomontaggio / Photomontage

HN9755

IV 194 K



DR, 2-tlg. Set Kühlwagen, „Köstritzer Bier“

DR, set de 2 vagones refrigerados de dos ejes, “Köstritzer Bier”

DR, set di 2 carri refrigeranti, “Köstritzer Bier”

DR, coffret de 2 wagons réfrigérés, « Köstritzer Bier »

DR, 2-unit set of refrigerated wagons, “Köstritzer Bier”



NEW

Fotomontage / Fotomontaje / Fotomontaggio / Photomontage

HN9756

IV 97 K



DR, Kühlwagen „Margon-Wasser“

DR, vagón refrigerado de 2 ejes “Margon-Wasser”

DR, carro refrigerante “Margon-Wasser”

DR, wagon réfrigéré « Margon-Wasser »

DR, refrigerated wagon “Margon-Wasser”



NEW

Fotomontage / Fotomontaje / Fotomontaggio / Photomontage

HN9757

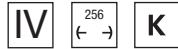

DB, 2-tlg. Set 4-achsiger Silowagen „NACCO“, graue Farbgebung

DB, set de 2 vagonos tolva de 4 ejes “NACCO”, decoración gris

DB, set di 2 carri silo a 4 assi “NACCO”, livrea grigia

DB, coffret de 2 wagons-silos à 4 essieux « NACCO », livrée grise

DB, 2-unit set of 4-axle silo wagons “NACCO”, grey livery



NEW

HN9758

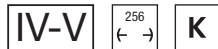

SNCF, 2-tlg. Set Getreidesilowagen „Transcéréales – ALGECO“, mit runden Wänden

SNCF, set de 2 vagonos tolva de cereales “Transcéréales – ALGECO”, con paredes redondeadas

SNCF, set di 2 carri tramoggia per trasporto cereali “Transcéréales – ALGECO”, con pareti arrotondate

SNCF, coffret de 2 wagons-trémie à céréales « Transcéréales – ALGECO », avec parois arrondies

SNCF, 2-unit set of cereal hopper wagons “Transcéréales – ALGECO”, with rounded walls



NEW

HN9759

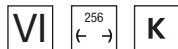

CZ-interfracht, 2-tlg. Set 4-achs. Getreidesilowagen, neongrüne Farbgebung

CZ-interfracht, set de 2 vagonos tolva de 4 ejes, decoración verde neón

CZ-interfracht, set di 2 carri silo a 4 assi, livrea verde neon

CZ-interfracht, coffret de 2 wagons-silos à 4 essieux, livrée vert néon

CZ-interfracht, 2-unit set of 4-axle silo wagons, neon green livery



NEW

HN9760

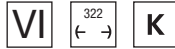

NEW



2-tlg. Set 4-achs. Containertragwagen, 2 x 45'-Container „P & O Ferrymasters“, in blauer bzw. gelber Farbgebung

Set de 2 wagons portacoteneadores de 4 ejes, con 2 coteneadores de 45' "P & O Ferrymasters", en decoraci3n azul y amarilla

Set di 2 carri porta-container a 4 assi, con 2 container da 45' "P & O Ferrymasters", in livrea blu e gialla

coffret de 2 wagons porte-coteneurs 2 4 essieux, avec 2 coteneurs de 45' « P & O Ferrymasters », livr3e bleue et jaune

2-unit set of 4-axle container wagons, 2 x 45' container "P & O Ferrymasters" in blue and yellow livery

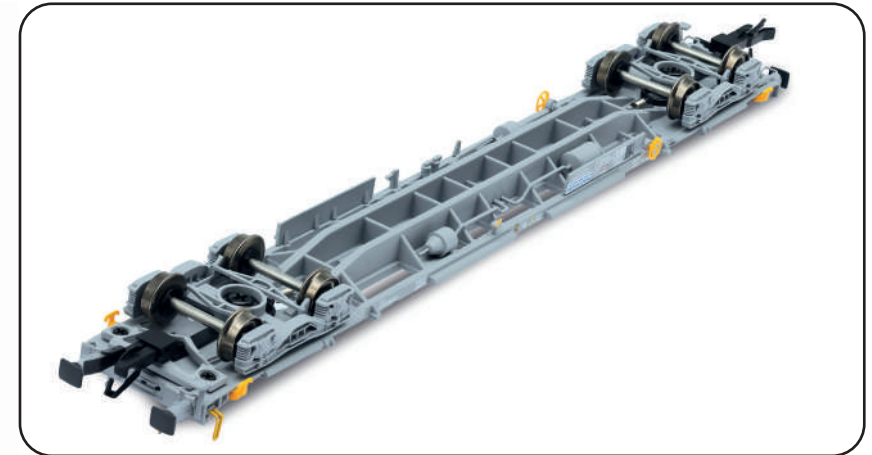

Von Deutschland bis nach Großbritannien

Die Arnold-Modelle der F3hrbootcontainerwagen Sffgmss bereichern jede Spur-TT-Anlage mit ihrer originalgetreuen Nachbildung. Die Vorbilder diese Containerwagen franz3sischen Ursprungs verbinden Europa und Gro3britannien im G3terverkehr durch den Kanaltunnel und k3nnen durch ihre charakteristisch niedrige Bauart auch gro3volumige 45'-Container transportieren.

Die Arnold-Modelle 3berzeugen durch ihre Ganzmetallbauweise sowie eine hochwertige Lackierung und Beschriftung. Mit ihrer pr3zisen Umsetzung sind sie die perfekte Erg3nzung f3r moderne G3terzugkompositionen, speziell auch f3r Z3ge, die beim Vorbild sowohl in Deutschland, Frankreich als auch in England von Lokomotiven des Typs „Class 66“ gezogen werden.



HN9761

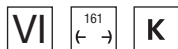

NEW



4-achs. Containertragwagen, grau, mit weißem 45'-Container „DB Schenker“

Vagón portacontenedores de 4 ejes, con 1 contenedor de 45' "DB Schenker", decoración gris

Carro porta-container a 4 assi, con 1 container da 45' "DB Schenker", livrea grigia

Wagon porte-conteneurs à 4 essieux, avec 1 conteneur de 45' « DB Schenker », livrée grise

4-axle container wagon, grey livery, with 45' container "DB Schenker"



HN9762

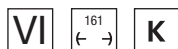

NEW



4-achs. Containertragwagen, grau, mit weißem 45'-Container „ONE“

Vagón portacontenedores de 4 ejes, con 1 contenedor de 45' "ONE", decoración blanca

Carro porta-container a 4 assi, con 1 container da 45' "ONE", livrea bianca

Wagon porte-conteneurs à 4 essieux, avec 1 conteneur de 45' « ONE », livrée grise

4-axle container wagon, with 45' container "ONE", white livery



Bereits lieferbar • Encore disponibles • Ancora disponibili • Aún disponibles • Still available

Die als „bereits lieferbar“ gekennzeichneten Produkte könnten in begrenzter Menge verfügbar sein oder bereits ausverkauft sein

Les produits indiqués comme « déjà disponibles » pourraient être disponibles en quantité limitée ou déjà épuisés

I prodotti segnalati come "ancora disponibili" potrebbero essere disponibili in quantità limitata o già esauriti

Los productos marcados como «aún disponibles» pueden estar disponibles en cantidad limitada o ya agotados

Products marked as "still available" may be available in limited quantity or already sold out



HN9057/HN9057S

Cargo Logistik Rail Service, Diesellokomotive DE 18 001, in roter Farbgebung, Ep. VI



- Gleichstrommodell, digital mit Sound
- Digitalschnittstelle NEM 662 (Next 18)



HN9058/HN9058S

DB/NorthRail, Diesellokomotive Vossloh DE 18, in hel- lgrauer Farbgebung, Ep. VI



- Länge über Puffer: 142 mm
- Motor mit Schwungmasse



HN9059/HN9059S

RailAdventure, Diesellokomotive Vossloh DE 18, in grauer Farbgebung, Ep. VI



- Spitzen- und Schlussbeleuchtung wechselnd mit der Fahrtrichtung



HN9062/HN9062D

DRB, Diesel-Rangierlokomotive Kö 4498 mit offenem Führerhaus, Ep. II



- Gleichstrommodell, digital mit DCC-Decoder
- Digitalschnittstelle NEM 662 (Next 18)



HN9064

DR, Diesel-Rangierlokomotive Kö 5741 mit offenem Führerhaus in schwarzer Lackierung, Ep. III



- Länge über Puffer in 53 mm
- Motor mit Schwungmasse



HN9066/HN9066S

P.St.E.V., Dampflokomotive G 12, mit dreidomigem Kessel, in grün/brauner Lackierung, Ep. I



- Rahmen, Lokkessel, Tenderfahrwerk und Gehäuse aus Metallspritzguss
- Je nach Modellausführung besitzt die Lokomotive ein- en drei- bzw. vierdomigen Kessel, Glocke sowie einen Kohlekastenaufsatz und Gastank auf dem hinteren Ende des Tenders



HN9067/HN9067S

DR, Dampflokomotive 58 1228, vierdomiger Kessel, mit zwei Spitzenlichtern, Ep. III



- Alle Lampen je nach Fahrtrichtung beleuchtet und im Digitalbetrieb schaltbar
- Alle Modellausführungen auch mit Sound erhältlich
- Digitalschnittstelle nach NEM 662 („Next 18“)



HN9068/HN9068S

DR, Dampflokomotive 58 1111-2, dreidomiger Kessel, mit drei Spitzenlichtern, Ep. IV



- Analogversion vorbereitet für den Einbau eines Rechtecklautsprechers (15 x 11 mm)
- Mindestradius: 310 mm
- Länge über Puffer: 154 mm
- Gewicht: ca. 130 g.



HN9521

DR, 4-tlg. Doppelstockeinheit ohne Steuerabteil in blau/hellgrauer Lackierung, Ep. IV



Fotomontage / Fotomontage / Photomontage / Fotomontaggio



HN9522

DR, 2-tlg. Doppelstockeinheit mit Steuerabteil in blau/hellgrauer Lackierung, Ep. IV



Fotomontage / Fotomontage / Photomontage / Fotomontaggio



HN9523

DR, 4-tlg. Doppelstockeinheit mit Steuerabteil, in grüner Farbgebung mit grauem Dach, Ep. III



HN9524

DR, 4-tlg. Doppelstockeinheit ohne Steuerabteil, in grüner Farbgebung mit grauem Dach, Ep. IV



HN9746

DR, 3-tlg. Set von 4-achs. Selbstentladewagen der Bauart Fac[6841] mit niedrigen Wagenkastenaufbauten, 2. Serie, braune Lackierung, Ep. IV



- Chassis aus Metall für gute Schwerpunktage
- HN9746 – Bauart Fac[6841], Ausführung mit niedrigem Wagenkastenaufbau
- HN9747 – Bauart Facs[6843], Ausführung mit hohem Wagenkastenaufbau
- detaillierte Nachbildung der Bedienhebel (ohne Funktion)
- feine Lackierung und Beschriftung
- Kurzkupplungskinematik an beiden Enden der Wagen



HN9747

DR, 3-tlg. Set von 4-achs. Selbstentladewagen der Bauart Fac[6843] mit hohen Wagenkastenaufbauten, 2. Serie, braune Lackierung, Ep. IV



ACCESSORIES

HC8063

- 10 Stk. - ARNOLD Magnetkupplungen (N und TT)
- 10 uds - Enganches magnéticos ARNOLD (N y TT)
- 10 pz - Accoppiamenti magnetici ARNOLD (N e TT)
- 10 pcs - Attelages magnétiques ARNOLD (N et TT)
- 10 pcs - ARNOLD magnetic couplings (N and TT)

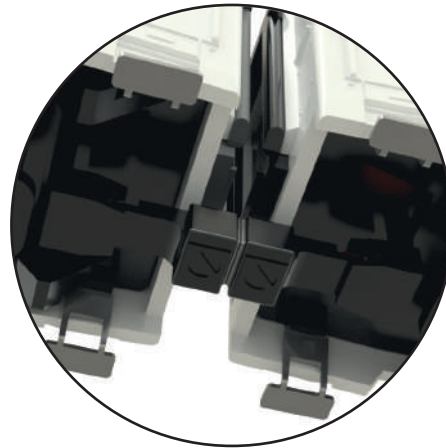

NEW

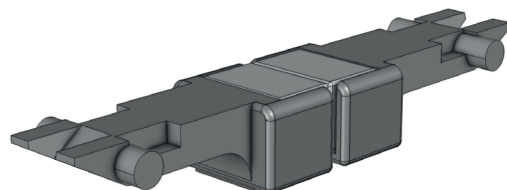
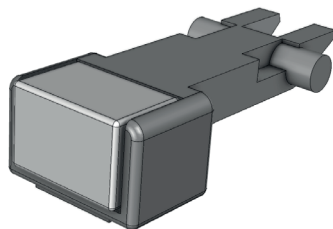
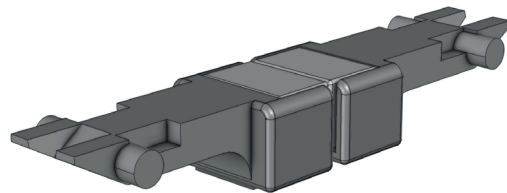

Neu für Spur N und TT: ARNOLD Magnetkupplungen

Schluss mit dem ungewollten Entkuppeln an Neigungswechseln, auf Weichen etc.!
Die neuen ARNOLD-Magnetkupplungen garantieren einfaches Kuppeln und Entkuppeln sowie ein entkupplungssicheres Fahren für ungetrübte Spielfreude. Passend für alle Kupplungsaufnahmen nach NEM 355.

Nuevo para ancho de vía N y TT: Enganches magnéticos ARNOLD

Se acabaron los desacoplamiento indeseados en los cambios de rasante, en las agujas, etc.
Los nuevos enganches magnéticos ARNOLD garantizan un acoplamiento y desacoplamiento sencillos, así como una marcha segura y una experiencia de juego satisfactoria. Aptos para todos los cajetines NEM 355.

Novità per gli scartamenti N e TT: Accoppiamenti magnetici ARNOLD

Niente più disaccoppiamenti indesiderati nei cambi di pendenza, sui punti, ecc.
I nuovi accoppiatori magnetici ARNOLD garantiscono un semplice accoppiamento e disaccoppiamento, nonché una marcia sicura per il divertimento di gioco. Adatti a tutte le tasche degli accoppiatori NEM 355.

Nouveau pour les échelles N et TT : Attelages magnétiques ARNOLD

Fini les désaccouplements intempestifs aux changements d'inclinaison, sur les aiguillages, etc.
Les nouveaux attelages magnétiques ARNOLD garantissent un attelage et un dételage faciles ainsi qu'une conduite sans risque de désaccouplement pour un plaisir de jeu intact. Convient à tous les logements d'attelage selon NEM 355.

New for N and TT gauge: ARNOLD magnetic couplings

No more unwanted uncoupling at changes of gradient, on point tracks etc.!
The new ARNOLD magnetic couplers guarantee simple coupling and uncoupling as well as uncoupling-safe running for unclouded playing enjoyment. Suitable for all NEM 355 coupler pockets.

HC6000

Arnold TT (1: 120) Bahnhof 'Wiesenthal'

Arnold TT (1: 120) Estación de tren 'Oberwiesenthal'
Arnold TT (1: 120) Stazione Ferroviaria 'Oberwiesenthal'
Arnold TT (1: 120) Gare ferroviaire 'Oberwiesenthal'
Arnold TT (1:120) Railway Station 'Oberwiesenthal'

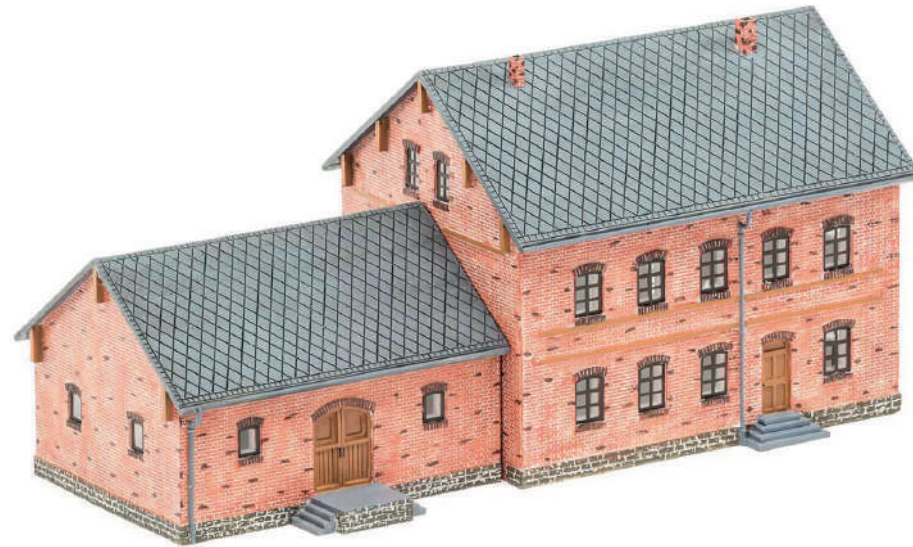

HC6003

Arnold TT (1: 120) Kleiner Lokschuppen 'Wiesenthal'

Arnold TT (1:120) Cobertizo para motores pequeños "Oberwiesenthal"
Arnold TT (1:120) Rimessa per piccoli motori "Oberwiesenthal"
Arnold TT (1: 120) Hangar à petits moteurs 'Oberwiesenthal'
Arnold TT (1:120) Small engine shed 'Oberwiesenthal'





HM DCC

7000

REVOLUTIONISING THE CONTROL & OPERATION OF MODEL RAILWAYS

Although DCC offers many advantages over conventional DC control there are still several disadvantages. With the currently available DCC systems good and consistent control relies on the command signals being passed down the track to the chosen locomotives. Any break in the command signals reaching the chosen locomotive due to poor track connections or possibly dirt on the track can result in the model stalling. This can be quite frustrating especially if the locomotive has to go through a start up sequence before moving off once more.

Changing a locomotive's CV (Configuration Variables) settings can also become a challenge as normally models have to be lifted from the track and placed on a Programming Track before CVs can be changed. Changing a locomotive's CV settings while still on the layout can result, annoyingly with all locomotives being affected by the change, however Hornby are once again on the cutting edge of innovation and operating a model railway has entered a new age of control.

The HM7000 model railway control series offers many advantages over the existing old style DCC units. Firstly, it uses an app based Bluetooth protocol and can be downloaded on to the majority of available smart phones and tablets, which in turn can then be used to control a model railway. No more expensive Command Base units as the HM7000 app is totally free, just scan the HM7000 QR code and follow the instructions. It is that simple.

Secondly, there are 3 available sound decoders - 21 pin, Next 18 pin and 8 pin decoders. Each decoder is Bluetooth enabled and is supplied complete with detachable sugar cube speaker and multi sized sound box to provide maximum depth of sound, given the available space. Initially, there are in excess of 30 free downloadable sound files to suit the more popular steam, diesel and electric locomotives with each file having in excess of 20 individual sounds.

For those who prefer to run silently, there are 4 non sound Bluetooth decoders - 21 pin, Next 18 pin, 8 pin and 6 pin.

Each of the Bluetooth decoders, be they sound or non-sound incorporate a mini socket that allows for the fitting of an HM7070 Power Bank module. The Power Bank provides up to 9 seconds of backup power should the locomotive encounter a power outage due to dirty or poor track work.

The versatility of the new Hornby HM7000 Bluetooth enabled control system is superbly highlighted with the numerous and low cost ways that any existing layout, either DC or DCC can be controlled using the power of the HM7000 system while wholeheartedly embracing Bluetooth technology.



- Full Bluetooth wireless control via APP based control interface
- Over the Air (OTA) updates to HM7000 decoders
- Bluetooth mesh architecture for multiple HM device control
- **Free-to-download** app for Android and iOS dedicated for decoder control
- High fidelity Triplex TXS decoders allowing for simultaneous play of multiple sounds including:
 - Backwards compatible with Xpressnet DC control systems
 - Locomotive Sound types for Diesel, Diesel-Electric, Steam, Steam-Electric
- Other advanced decoder features were created to allow enhanced control of the locomotive and the sound system

GET STARTED WITH HM7000 IN JUST FIVE SIMPLE STEPS!

1 Buy HM7000 DCC decoder

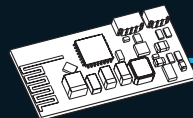

2 Scan the QR code



3 Download the **FREE** app



4 Download the **FREE** sounds



5 Start controlling



Welcome to Hornby TT:120

Hornby TT:120 is a TableTop model railway format that uses an internationally recognised scale of 1:120 or in simple terms, 1 / 10th of a foot and is a perfect scale for those of all ages who may be limited for space.

Currently, the mainstream UK scales for model railways are either '00' or 'N'. With '00' you have the advantage of models being easy to handle but you need space to create a meaningful layout. With 'N' you have the benefit of being able to create a complicated layout in a small space but the models are difficult to handle with ease. However, with Hornby TT:120 you get the best of both worlds.

Hornby TT:120 models can be easily handled by both young and old, plus there is the additional advantage that a reasonably sized and interesting layout can be created on a baseboard which can easily be stored away either under a bed, behind a wardrobe or some other convenient small space.

The current selection of Hornby TT:120 range of locomotives, rolling stock, buildings and track continues to expand with new and exciting models being added to the range on a continuous basis. With the addition of SkaleScenics and the broad selection of track sections, plus additional scenic accessories becoming available on a continuous basis, a model railway can soon evolve into an easily manageable and eye-catching Table Top model railway.

All Hornby TT:120 locomotives and rolling stock are fitted with universally accepted couplings.



Image shows HM7000 app based analogue control uk.hornby.com/hm7000

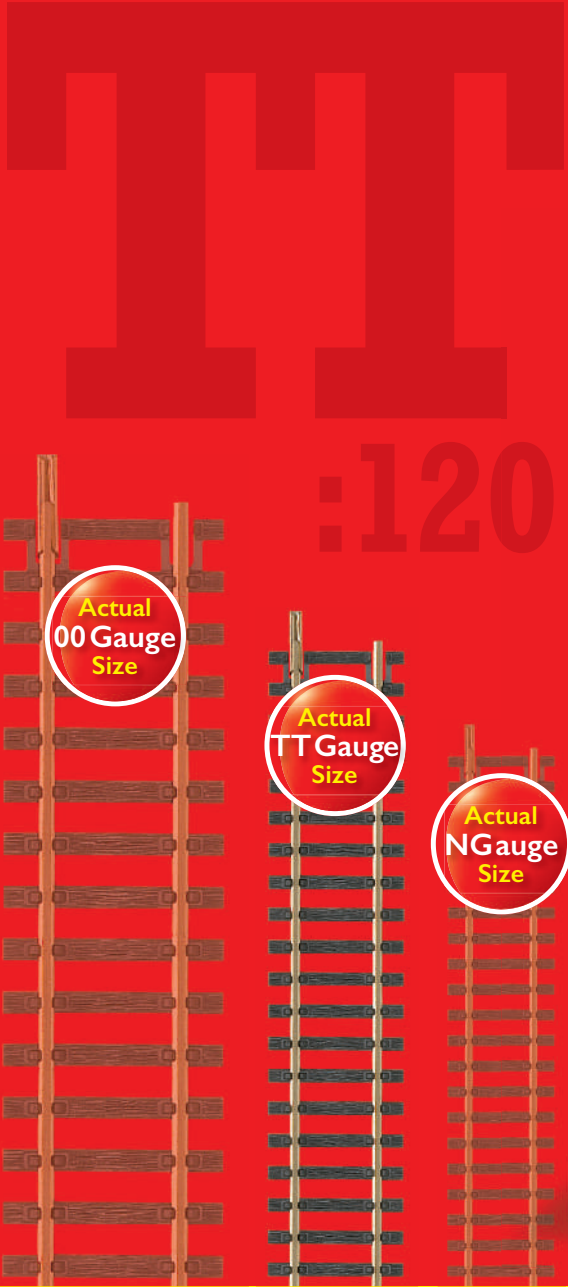

Actual 00 Gauge Size

Actual TT Gauge Size

Actual N Gauge Size

The current range of Hornby TT:120 train sets include a standard Hornby DC Controller, however the locomotives are capable of being converted to DCC with the addition of a suitable Next18 DCC decoder. Once fitted the locomotive can be operated via any compatible DCC control system such as those produced by Hornby.

Each set includes an oval of track with siding, however with the addition of Hornby TT:120 Track Extension Packs an impressive model railway layout can be created in easy and straightforward stages as shown on the opposite page.

Should the more adventurous wish to create their own individual layout the Hornby TT:120 track system has multiple track pieces across different radius with more to come.

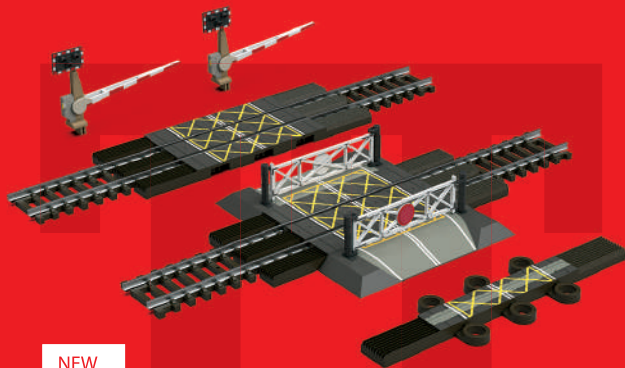

NEW

TT8044 Level Crossing

This single-track level crossing can be adapted perfectly to suit your layout needs:

- Optional steam era and modern era gates.
- Can be assembled in a single and double track configuration.
- This pack includes track sections.
- Track section length is 166mm.

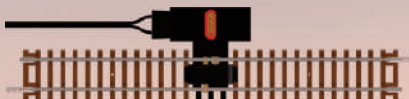

TT8001 Power Connecting Track 166mm



TT8002 Straight Track - 166mm



TT8011 Quarter Straight Track - 41.5mm



TT8012 Half Straight Track - 83mm



TT8003 Standard Double Straight



TT8013 Uncoupler Ramp - 166mm

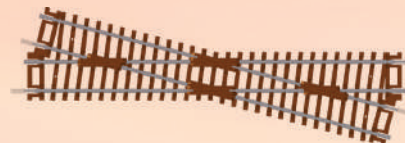

TT8019 Diamond Crossing Left Hand 166mm

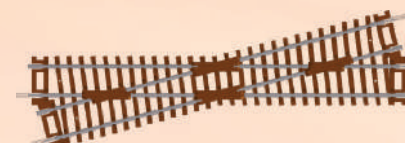

TT8018 Diamond Crossing Right Hand 166mm



TT8008 Left Hand Point - 166mm 15° 631mm



TT8009 Right Hand Point - 166mm 15° 631mm



TT8014 Quarter Curve 1st Radius 7.5° 267mm

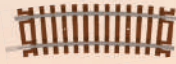

TT8020 Half Curve 1st Radius 15° 267mm



TT8015 Half Curve 2nd Radius 15° 310mm



TT8016 Half Curve 3rd Radius 15° 353mm



TT8003 Curve 1st Radius - 30° 267mm



TT8004 Curve 2nd Radius - 30° 310mm



TT8005 Curve 3rd Radius - 30° 353mm



TT8017 Half Curve 4th Radius 15° 396mm



TT8006 Curve 4th Radius - 30° 396mm



TT8007 Curve 6th Radius - 15° 640mm



NEW

TT8045 Home Signal



NEW

TT8046 Distant Signal



NEW

TT8047 Junction Home Signal



NEW

TT8048 Junction Distant Signal



TT8010 Buffer Stop



TT8026 Locomotive & Rolling Stock Railer



TT8027 Power Connecting Clip



TT8028 Digital Power Connecting Clip



TT8040 Coupling Assemblies (Pack 10)



TT8038 Con Rod Spanner



NEW

TT8042 Isolating Fishplates

TT8035 DCC Track Turnout Clip

TT8025 4 x Power Track Pins

TT8036 Fishplate Pack

Track Extension Packs

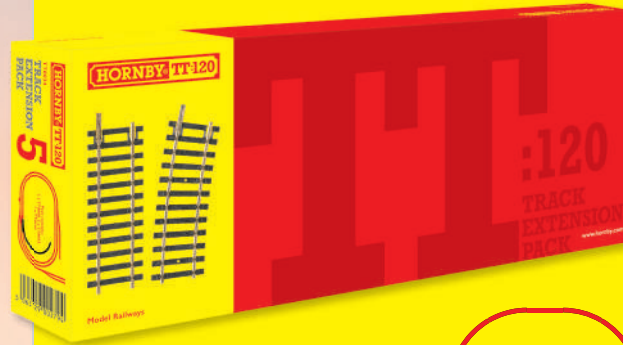

Expand your Hornby TT:120 layout with additional track extension packs, buildings and accessories.

Base oval

TT8031
TRACK
EXTENSION
PACK

2

Pack contains:
6 x TT8004, 1 x TT8007,
1 x TT8009, 3 x TT8002,
1 x TT8010

TT8030
TRACK
EXTENSION
PACK

1

Pack contains:
1 x TT8008, 1 x TT8007,
5 x TT8002, 1 x TT8010

TT8032
TRACK
EXTENSION
PACK

3

Pack contains:
6 x TT8004, 1 x TT8006,
2 x TT8009

TT8033
TRACK
EXTENSION
PACK

4

Pack contains:
2 x TT8006, 1 x TT8007,
1 x TT8009, 2 x TT8002,
1 x TT8010

TT8034
TRACK
EXTENSION
PACK

5

Pack contains:
1 x TT8008, 5 x TT8003,
1 x TT8010

TrakMat Dimensions:
1371mm x 1020mm



TT:120 Track Plans

Where do you start with laying down your 'TT' track? How can you organise track pieces for your layout? These are common questions associated with beginners about to dabble in a particular scale. With Hornby TT:120 being ideal for fitting in smaller spaces, the following track plans will enable you to extend your track from a basic oval or allow for alternative types of layouts.

The track plans show TrakMat Extension Pods, Open Ended Extension Pods, Small Full Layouts, Medium Full Layouts and Large Full Layouts. We also offer a free download on our website for the Train Set TrakMat at hornby.com/TT120 which is a great base for your first 'TT' layout.

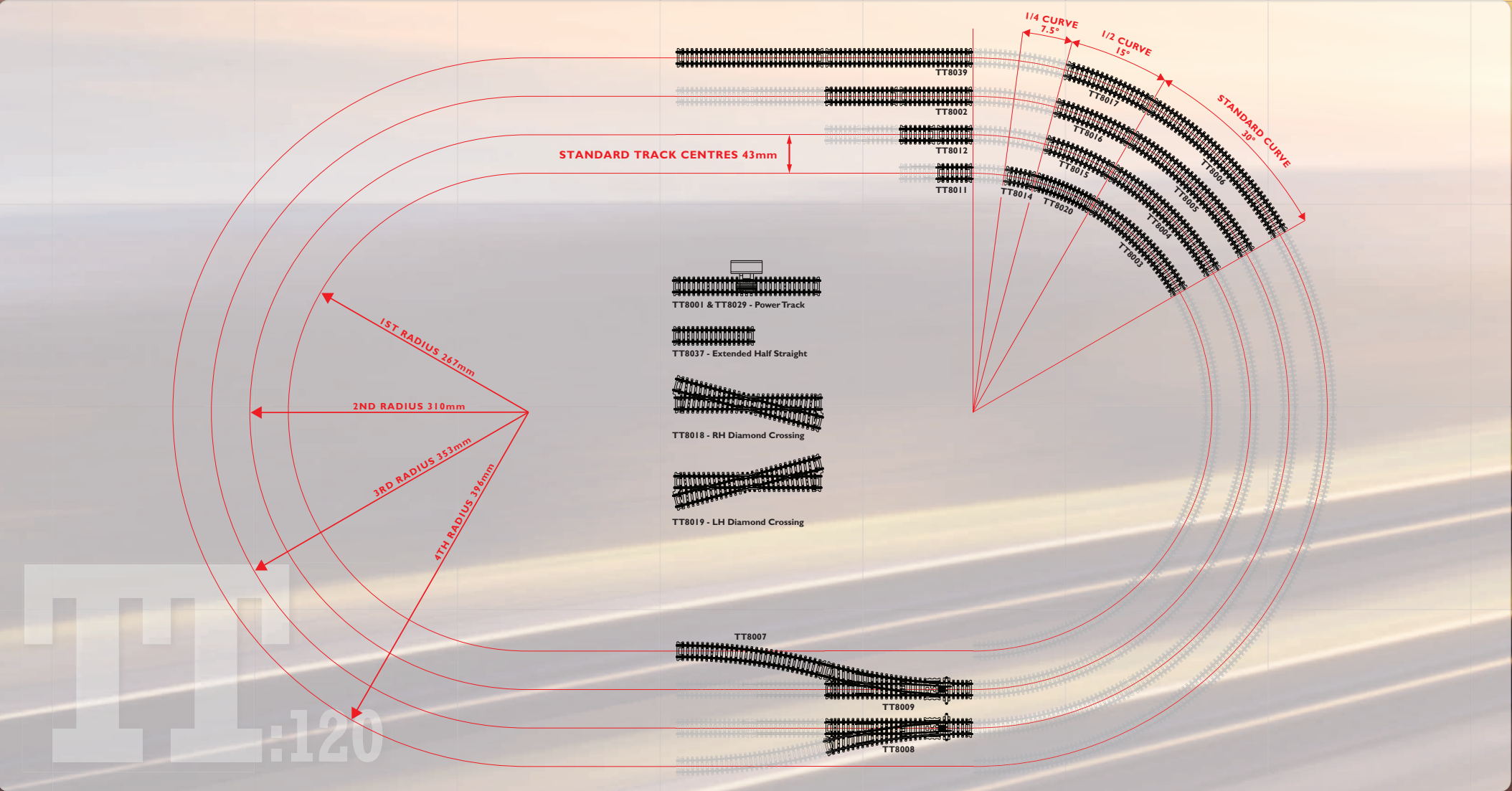

TrakMat Extension Pods

The following three TT TrakMat Extension Pods will help to extend your 'TT' layout from the basepod. Extension Pod 1 is 5' x 1' 6" (1524mm x 457mm) and features five track pieces, extending from the starter oval layout. Extension Pod 2 is 3' x 1' 6" (914mm x 457mm) while Extension Pod 3 measures at 4' 6" x 1' (1371mm x 300mm).

TT TrakMat Extension Pod 1
5' x 1' 6" (1524mm x 457mm)

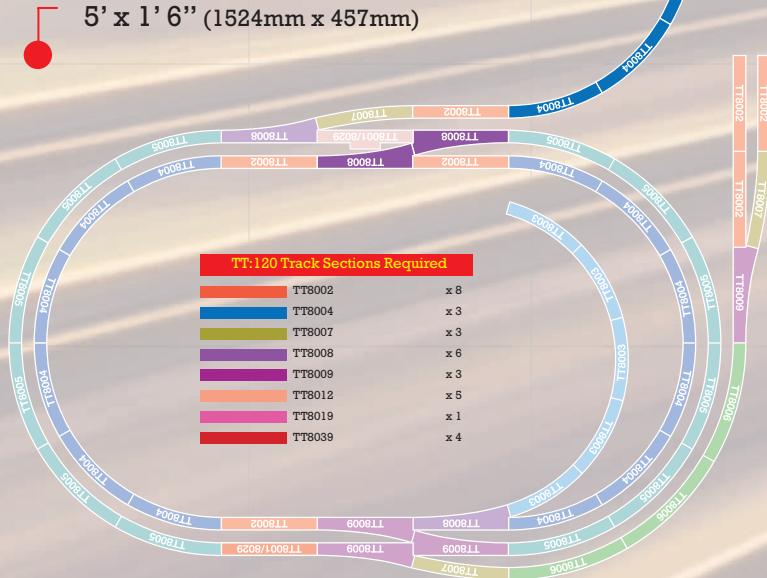

TT TrakMat Extension Pod 2
3' x 1' 6" (914mm x 457mm)

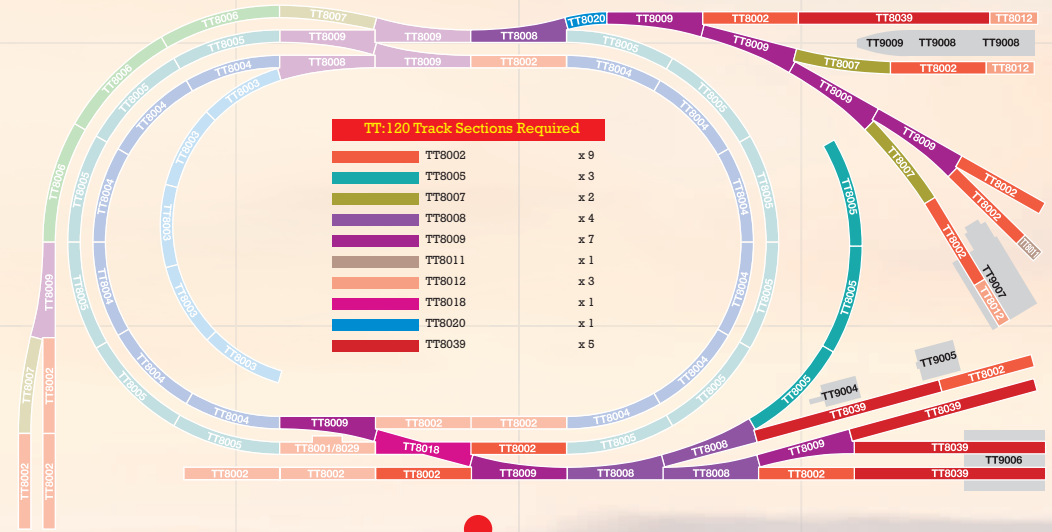

TT TrakMat Extension Pod 3
4' 6" x 1' (1371mm x 300mm)

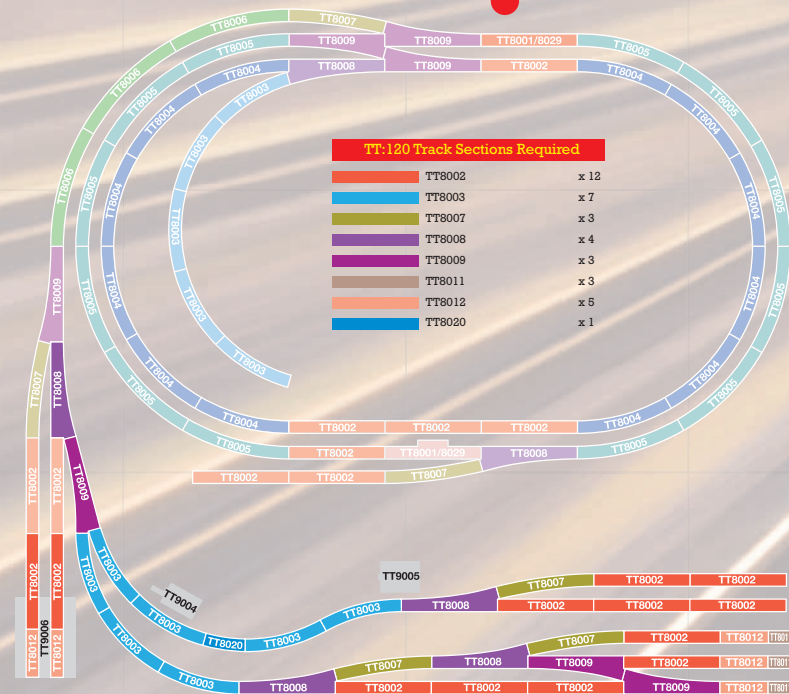

Small Full Layouts

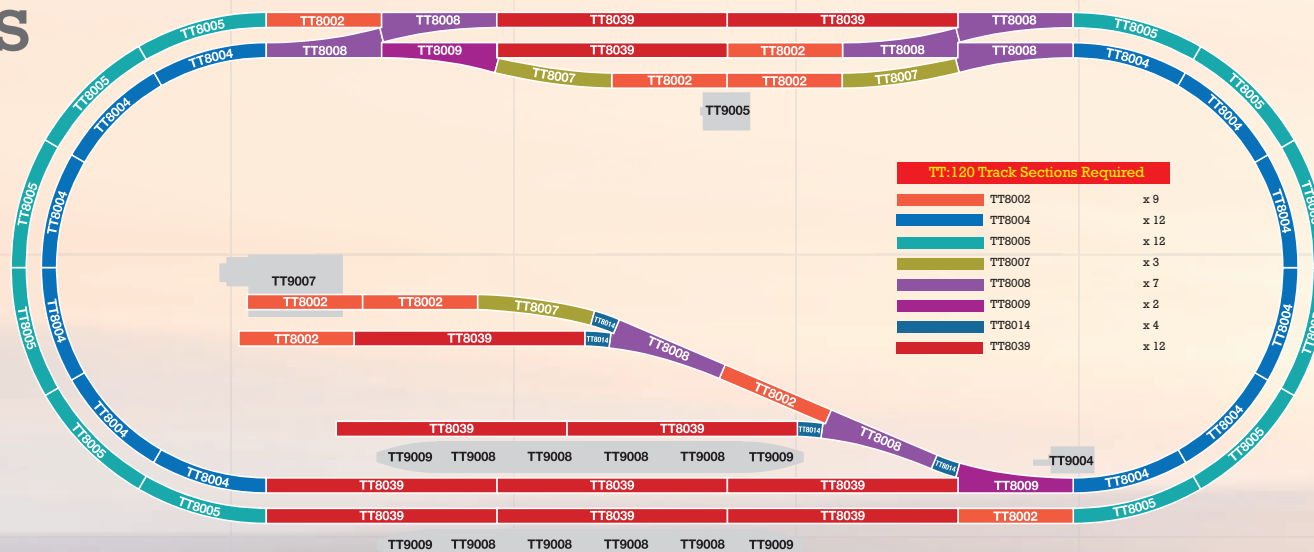

TT Small Full Layout 1
6' 5" x 3' (1956mm x 914mm)



TT Small Full Layout 2
6' 5" x 3' 5" (1956 mm x 1041 mm)

Medium Full Layouts

TT:120 Track Sections Required

TT8002	x 11
TT8003	x 13
TT8004	x 12
TT8005	x 12
TT8006	x 12
TT8007	x 5
TT8008	x 17
TT8009	x 16
TT8012	x 2
TT8014	x 2
TT8015	x 2
TT8020	x 1
TT8039	x 12

TT Medium Full Layout 1
6' 5" x 3' (1956mm x 914mm)

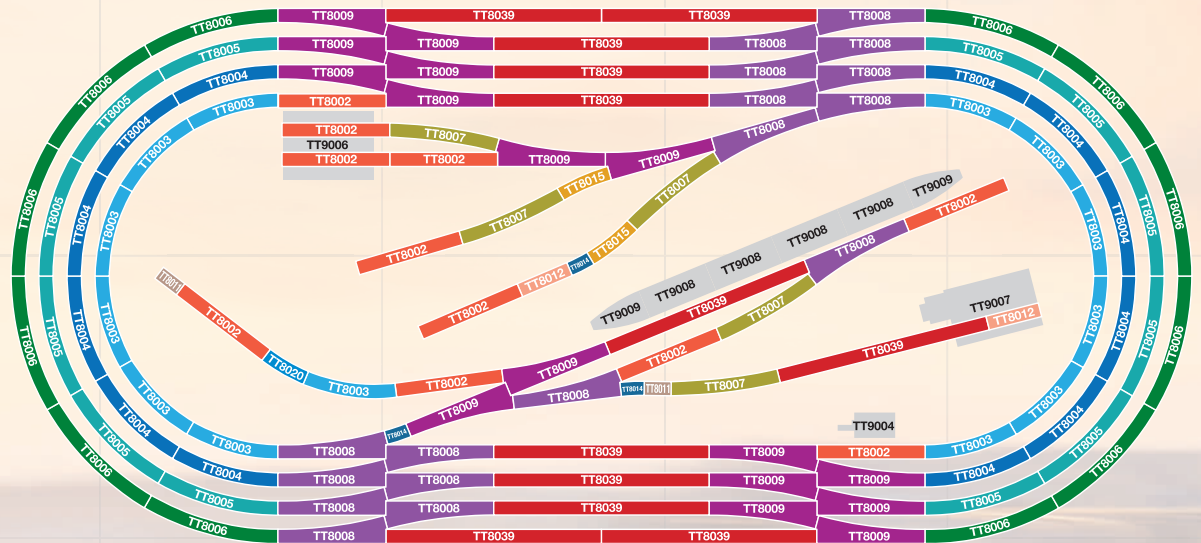

TT:120 Upcoming Track Plans

Large Full Layouts

FREE Train Set TrakMat Download at: hornby.com/HornbyTT120

Get started with your layout on our Hornby TT:120 Train Set TrakMat which you can download for free at hornby.com/TT120. This TrakMat is provided as the ideal base for your Hornby TT:120 layout at any time during the process of creating your desired diorama.

This Hornby TT:120 TrakMat has been designed to be used with the Hornby TT:120 basic oval as well as all 5 extension packs. To print the PDF to scale, you are likely to need to take or send it to a large format printer as it is 1371mm x 1020mm. We recommend that you ask for a matt laminate or encapsulate finish.

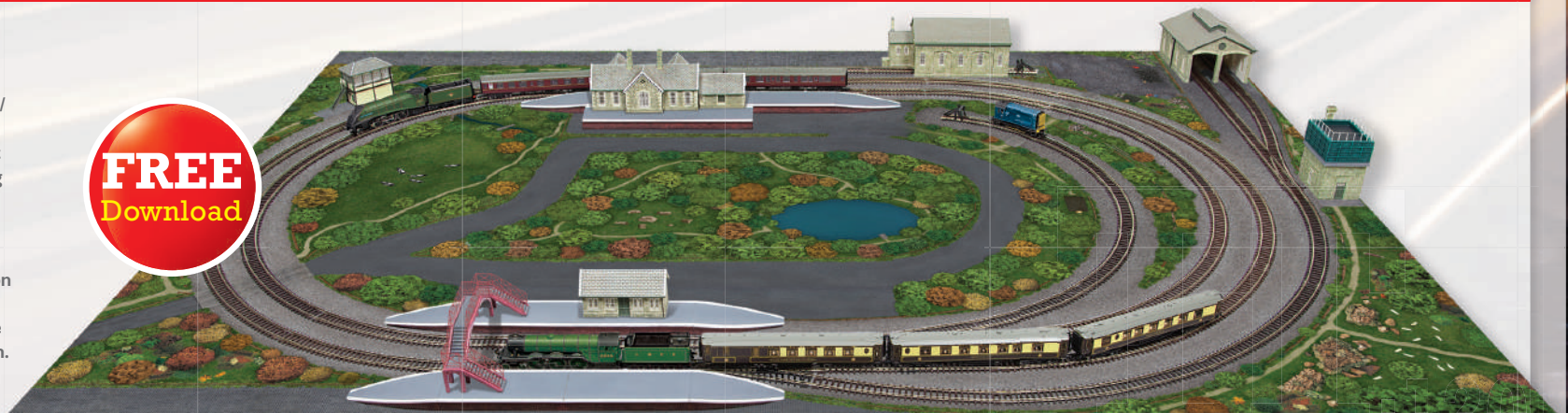

Buildings & Accessories

There are numerous Hornby TT:120 buildings planned for introduction over the coming months. Initially there will be a selection of stone effect station buildings and platforms based on those seen on the Settle & Carlisle line, produced from hand decorated resin heralding a whole plethora of structures that will steadily become available as the Hornby TT:120 range extends and will certainly provide even greater variety. Planned for introduction shortly will be a wide selection of structures, including a church, pub, shops. As time progresses an increased selection of buildings and structures will be appearing including a whole range of ancillary items that provide additional detail to any model railway layout.



TT9001 Footbridge



TT9002 S&C Dent Station



TT9003 S&C Waiting Room



TT9004 S&C Signal Box

TT:120 Scale Vehicles

Oxford Diecast TT:120 models are now available. Please visit www.oxforddiecast.co.uk



TT9005 S&C Water Tower



TT9006 S&C Engine Shed



TT9007 S&C Goods Shed



TT9010 Church 'St. Andrews'



TT9011 Pub 'The Bush Inn'



TT9012 Bungalow 'Avalon'



TT9013 Scottish Croft 'Shepherds Rest'



TT9014 Left Hand Terraced House



TT9015 M. Wilkes' Photographers



TT9016 The Bookworm Book Shop



TT9009 Platform Ramp x 2

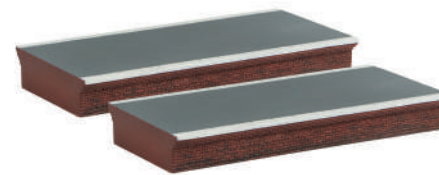

TT9008 Straight Platform x 2

- I20LAN2001** Land Rover Series 2 LWB Hard Top British Rail
- I20MM059** Morris 1000 British Rail
- I20OB001** Bedford OB Coach British Rail
- I20DEN001** Dennis F12 Pump Escape London Fire Brigade
- I20MH003** Scammell Mechanica I Horse Flat Trailer GWR
- I20LAN2011** Land Rover Series 2 LWB Canvas Bronze Green
- I20AT001** Austin Low Loader Taxi Black
- I20AT002** Austin Low Loader Taxi Oxford Blue
- I20MH004** Scammell Mechanica I Horse Van Trailer LNER
- I20OB002** Bedford OB Coach Southdown

All items are licensed with the relevant licensing companies by Oxford Diecast Ltd.

MAIN INDEX 2025

ARNOLD		HN2638/D	PAG 26	HN3513	PAG 50	HN4493	PAG 69	HN6702	PAG 81
HN2544/S	PAG 17	HN2639/D	PAG 26	HN3514	PAG 51	HN4498	PAG 62	HN6703	PAG 83
HN2545/S	PAG 17	HN2640/D	PAG 27	HN3515	PAG 53	HN4499	PAG 62	HN6704	PAG 83
HN2546/S	PAG 16	HN2643/S	PAG 32	HN4377	PAG 57	HN4500	PAG 64	HN6705	PAG 86
HN2597/S	PAG 10	HN2644/S	PAG 33	HN4387	PAG 54	HN4501	PAG 64	HN6706	PAG 86
HN2598/S	PAG 12	HN2645/S	PAG 36	HN4458	PAG 68	HN4502	PAG 65	HN6707	PAG 84
HN2608/S	PAG 30	HN2646/S	PAG 38	HN4459	PAG 68	HN4503	PAG 65	HN6708	PAG 84
HN2610/S	PAG 31	HN2647/S	PAG 39	HN4470	PAG 70	HN4504	PAG 55	HN6709	PAG 85
HN2611/S	PAG 43	HN2648/S	PAG 41	HN4472	PAG 70	HN4505	PAG 78	HN6710	PAG 85
HN2612/S	PAG 42	HN2649/S	PAG 41	HN4474	PAG 57	HN4506	PAG 79	HN6711	PAG 89
HN2616/S	PAG 45	HN2650/S	PAG 40	HN4478	PAG 74	HN4507	PAG 56	HN6712	PAG 89
HN2617/S	PAG 46	HN2651/S	PAG 19	HN4479	PAG 75	HN4508	PAG 56		
HN2618/S	PAG 47	HN2653/S	PAG 18	HN4480	PAG 76	HN6633	PAG 81		
HN2619/D/S	PAG 49	HN2654/S	PAG 20	HN4481	PAG 72	HN6634	PAG 81		
HN2620/D/S	PAG 50	HN2655/S	PAG 21	HN4482	PAG 73	HN6635	PAG 82		
HN2621/D/S	PAG 51	HN2656/S	PAG 21	HN4483	PAG 73	HN6670	PAG 87		
HN2622/D/S	PAG 53	HN2657/S	PAG 28	HN4486	PAG 67	HN6671	PAG 87		
HN2623/S	PAG 35	HN2658/S	PAG 29	HN4487	PAG 67	HN6678	PAG 88		
HN2624/S	PAG 34	HN2659/S	PAG 29	HN4488	PAG 59	HN6679	PAG 88		
HN2625/S	PAG 35	HN2663/S	PAG 14	HN4489	PAG 59	HN6683	PAG 88		
HN2635/S	PAG 23	HN2664/S	PAG 15	HN4490	PAG 61	HN6687	PAG 82		
HN2636/S	PAG 24	HN2665/S	PAG 15	HN4491	PAG 61	HN6700	PAG 80		
HN2637/S	PAG 25	HN3512	PAG 49	HN4492	PAG 69	HN6701	PAG 80		

ARNOLD TT	
HN9069/HM	PAG 123
HN9070/HM	PAG 122
HN9071/HM	PAG 123
HN9072/S	PAG 121
HN9073/S	PAG 120
HN9754	PAG 124
HN9755	PAG 124
HN9756	PAG 124
HN9757	PAG 125
HN9758	PAG 125
HN9759	PAG 125
HN9760	PAG 126
HN9761	PAG 127
HN9762	PAG 127

STILL AVAILABLE INDEX 2025

ARNOLD		HN2556/D	PAG.94	HN2601/S	PAG.98	HN4361	PAG.103	HN4420	PAG.106
HN2351	PAG.91	HN2563/S	PAG.94	HN2603/D	PAG.99	HN4364	PAG.103	HN4421	PAG.99
HN2352	PAG.91	HN2564/S	PAG.94	HN2604/D	PAG.99	HN4365	PAG.103	HN4422	PAG.99
HN2353/S	PAG.91	HN2565/S	PAG.95	HN2605/D	PAG.99	HN4366	PAG.103	HN4423	PAG.99
HN2481/S	PAG.92	HN2566/S	PAG.95	HN2606/S	PAG.93	HN4367	PAG.103	HN4424	PAG.99
HN2483	PAG.92	HN2567/S	PAG.95	HN2626/S	PAG.100	HN4368	PAG.103	HN4425	PAG.106
HN2485	PAG.92	HN2569/S	PAG.95	HN2627/S	PAG.100	HN4383	PAG.104	HN4426	PAG.106
HN2486/S	PAG.92	HN2570/S	PAG.95	HN2628/S	PAG.100	HN4385	PAG.104	HN4428	PAG.106
HN2487/S	PAG.92	HN2571/S	PAG.96	HN2632/S	PAG.101	HN4390	PAG.104	HN4435	PAG.106
HN2490D	PAG.92	HN2572/S	PAG.96	HN2633/S	PAG.101	HN4391	PAG.104	HN4436	PAG.106
HN2494	PAG.92	HN2574/S	PAG.96	HN2634/S	PAG.101	HN4395	PAG.104	HN4437	PAG.106
HN2495	PAG.92	HN2575S	PAG.96	HN3503	PAG.101	HN4396	PAG.104	HN4440	PAG.106
HN2496/S	PAG.92	HN2577/S	PAG.97	HN3504	PAG.101	HN4405	PAG.104	HN4441	PAG.106
HN2517S	PAG.93	HN2578/S	PAG.97	HN3506	PAG.101	HN4406	PAG.104	HN4442	PAG.107
HN2521/S	PAG.93	HN2587/S	PAG.97	HN3510	PAG.95	HN4409	PAG.105	HN4443	PAG.107
HN2522/S	PAG.93	HN2588/S	PAG.97	HN3511	PAG.97	HN4410	PAG.105	HN4444	PAG.107
HN2523D	PAG.93	HN2592/D	PAG.97	HN4349	PAG.102	HN4411	PAG.105	HN4445	PAG.107
HN2525/D	PAG.93	HN2593/D	PAG.98	HN4351	PAG.102	HN4412	PAG.105	HN4446	PAG.107
HN2526/D	PAG.93	HN2594/D	PAG.98	HN4352	PAG.102	HN4413	PAG.105	HN4448	PAG.107
HN2547/S	PAG.93	HN2595/D	PAG.98	HN4355	PAG.102	HN4414	PAG.105	HN4449	PAG.107
HN2548/S	PAG.94	HN2596/D	PAG.98	HN4356	PAG.102	HN4417	PAG.105	HN4454	PAG.108
HN2549/S	PAG.94	HN2599/S	PAG.98	HN4359	PAG.102	HN4418	PAG.105	HN4455	PAG.108
HN2552/S	PAG.94	HN2600/S	PAG.98	HN4360	PAG.103	HN4419	PAG.105	HN4456	PAG.108

HN4457	PAG.108	HN6563	PAG.110	HN6606	PAG.113	HN6637	PAG.115	HN6677	PAG.117
HN4460	PAG.107	HN6565	PAG.110	HN6607	PAG.113	HN6638	PAG.115	HN6696	PAG.117
HN4461	PAG.107	HN6566	PAG.110	HN6608	PAG.113	HN6639	PAG.115	HN6697	PAG.117
HN4462	PAG.97	HN6567	PAG.111	HN6609	PAG.113	HN6640	PAG.115	HN6698	PAG.117
HN4463	PAG.97	HN6568	PAG.111	HN6610	PAG.113	HN6641	PAG.115	HN0503	PAG.117
HN4464	PAG.97	HN6570	PAG.111	HN6611	PAG.113	HN6644	PAG.115		
HN4467	PAG.108	HN6571	PAG.111	HN6612	PAG.113	HN6649	PAG.115		
HN4468	PAG.108	HN6572	PAG.111	HN6613	PAG.113	HN6650	PAG.116		
HN4469	PAG.108	HN6573	PAG.111	HN6615	PAG.114	HN6651	PAG.116		
HN4473	PAG.108	HN6574	PAG.111	HN6616	PAG.114	HN6653	PAG.116		
HN6517	PAG.109	HN6575	PAG.111	HN6617	PAG.114	HN6654	PAG.116		
HN6521	PAG.109	HN6576	PAG.101	HN6618	PAG.114	HN6655	PAG.116		
HN6522	PAG.109	HN6577	PAG.111	HN6619	PAG.114	HN6656	PAG.116		
HN6525	PAG.109	HN6581	PAG.112	HN6620	PAG.114	HN6657	PAG.116		
HN6532	PAG.109	HN6582	PAG.112	HN6623	PAG.114	HN6658	PAG.116		
HN6533	PAG.109	HN6584	PAG.112	HN6624	PAG.114	HN6659	PAG.116		
HN6534	PAG.109	HN6595	PAG.112	HN6625	PAG.114	HN6660	PAG.116		
HN6535	PAG.109	HN6597	PAG.112	HN6628	PAG.115	HN6666	PAG.116		
HN6537	PAG.109	HN6598	PAG.112	HN6629	PAG.115	HN6672	PAG.117		
HN6540	PAG.110	HN6602	PAG.112	HN6630	PAG.115	HN6673	PAG.117		
HN6548	PAG.110	HN6603	PAG.112	HN6631	PAG.115	HN6674	PAG.117		
HN6561	PAG.110	HN6604	PAG.112	HN6632	PAG.115	HN6675	PAG.116		
HN6562	PAG.110	HN6605	PAG.113	HN6636	PAG.115	HN6676	PAG.117		

STILL AVAILABLE INDEX 2025

ARNOLD TT	
HN9057/S	PAG.128
HN9058/S	PAG.128
HN9059/S	PAG.128
HN9062/D	PAG.128
HN9064	PAG.128
HN9066/S	PAG.128
HN9067/S	PAG.128
HN9068/S	PAG.128
HN9521	PAG.129
HN9522	PAG.129
HN9523	PAG.129
HN9524	PAG.129
HN9746	PAG.129
HN9747	PAG.129

All rights reserved.
Reproduction, even partial, is prohibited.
© Copyright Hornby Hobbies Ltd.

Produced and printed in Italy





© Hornby Hobbies Ltd.

HORNBY HOBBIES LTD

Westwood, Margate, Kent, CT9 4JX, UK

EU Authorised Representative:

Hornby Italia SRL
Viale dei Caduti, 52/A6, Castel Mella
(BS), Italy, 25030

www.arnoldmodel.com



/Arnold.Modelleisenbahnen



@hornbyinternational

DE 08000.00.26.27
Customerservices.de@hornby.com
Technicalservices.de@hornby.com

ES 900.67.03.41
Customerservices.es@hornby.com
Technicalservices.es@hornby.com

FR 801.87.00.06
Customerservices.fr@hornby.com
Technicalservices.fr@hornby.com

IT 800.01.98.50
Customerservices.it@hornby.com
Technicalservices.it@hornby.com

UK +44 (0)1843 233525
Customerservices.uk@hornby.com
Technicalservices.uk@hornby.com



HP2025NTT